

DIN RANGER Manual



The RANGER is a self-contained, device that provides sensor readings over an LTE-M1 or NB-IoT cellular network.

- DIN rail mount
- Powers attached sensors at 13V or 18V
- 3 Analog inputs. One 4-20mA, two selectable 4-20mA or 1-5V inputs
- RS485 Modbus Client port
- Three digital inputs report state, total counts and input frequency. K-Factor configurable for Flow Totalizing
- SPDT Latching relay for on/off control
- Configurable from the SignalFire Cloud website signal-fire.cloud
- SignalFire Cloud allows for data visualization, trending and alarming
- Supports MQTT Sparkplug B communication protocol for connection to other servers
- Compact and simple to install and maintain
- Local configuration and diagnostics available using the micro-USB port and the SignalFire RANGER ToolKit PC software
- Internal backlog of a minimum of 200,000 datapoints in the event of loss of signal. Backlog will be automatically sent when the RANGER reconnects
- GPS for locating assets

Specifications

2

Enclosure Size	6" tall × 5.2" deep x 1.6" thick
Power	8-28VDC. Average current < 2.5mA plus sensor current. (Peak TX current is 250mA)
Temperature Rating	-40°C to +85°C
Enclosure	DIN Rail Mount
SIM Card	Internal 4FF Nano SIM card (LTE Cat M SIM and data plan required)
Local config port	Standard micro-USB connector
Analog Inputs	Provides 13/18VDC, (selectable) to attached 4-20mA / 1-5VDC sensors. Three analog inputs built in.
Digital Inputs	Three digital inputs. Dry Contact or 30 Volts Max (push-pull), 2kHz max. Capable of reporting on state change (in application for frequency inputs for flow, pull up resistor is populated and not needed by client).
Relay Output	Latching Relay. 2A @ 30VDC, 0.3A @ 110VDC, 0.5A @ 125VAC
Sensor Power Output	Selectable 13VDC/18VDC. 60mA max power output
Compliance	<ul style="list-style-type: none">• Contains FCC ID: 2ANPO00NRF9160 and IC ID: 24529-NRF9160• PTCRB and Verizon Network Certified
Model Numbers	

Table of Contents

Specifications	2
Dimensions.....	5
Connections and Components.....	6
Setup	7
Sensor Connections.....	7
Analog Inputs	8
Digital Inputs	8
Relay Output	8
Modbus RS-485	9
Power	9
Antenna Connections.....	9
Sim Card Insertion.....	10
Interface Wiring	11
RANGER Configuration.....	14
Node Status Tile	15
Analog Input Tile	18
Digital Input Tile	19
DIN Flow Totalizer Tile	21
GPS Tile	22
Digital Output Tile	24
Relay Control.....	24
Modbus Tile	25
Historical Data View	27
Dashboards	28
Create Dashboards and Data Groups.....	28
Add data points to Data Group.....	28
Users	29
User Settings	29
User Roles	30
User View	31
Adding Users	31
Alarms	32
Alarm Views	32

State 32

Configure Alarms..... 33

Alarm Groups 35

Reports..... 36

Updating RANGER Firmware..... 37

 Single RANGER Firmware Update 37

 Bulk Firmware Update 37

Technical Support Contact and Information.....36

Dimensions

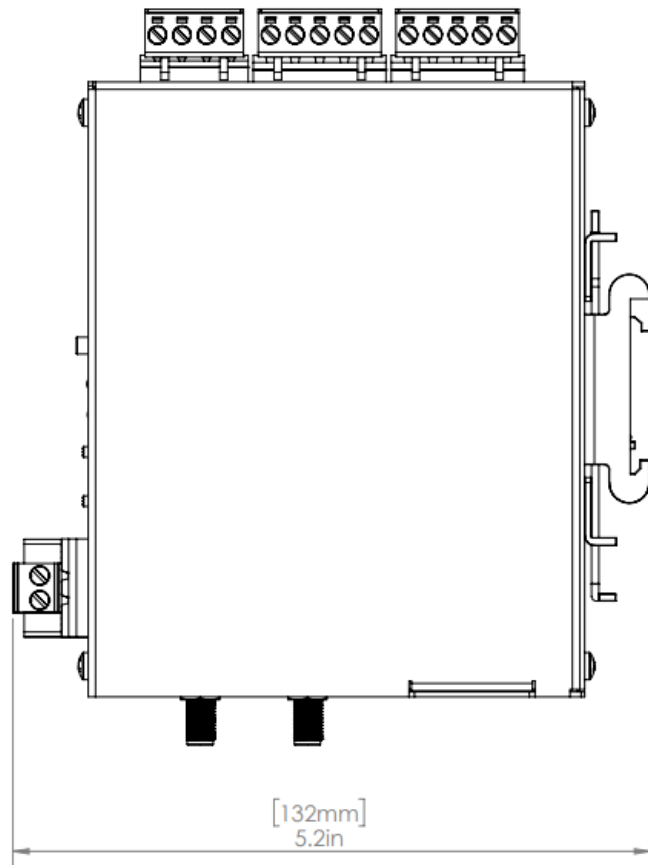
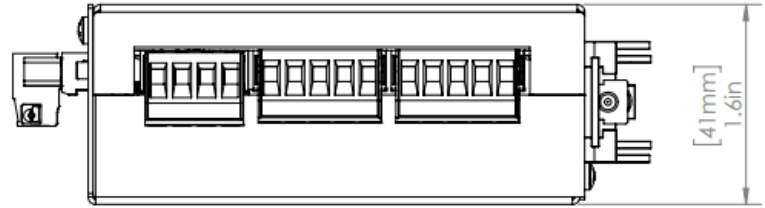
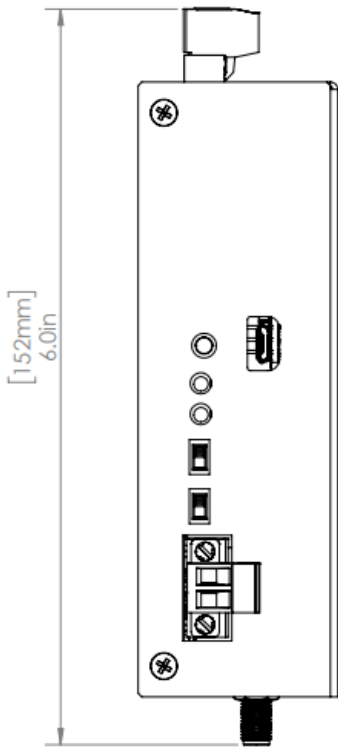

Connections and Components

STATUS LED

- The STATUS LED (green) will flash 3 times on a successful data transmission to the server

ERROR LED

- The ERROR LED (red) will blink 3 times to indicate that an attempted data transmission failed, RANGER not connected to the server

Check-in Button

- If this button is pressed the RANGER will blink the green or red status LED 3 times to indicate the status of the last transmission to the server. If the Check-in button is pressed and held for more than 1 second, the RANGER will take readings from the attached sensors and send the readings to the server.

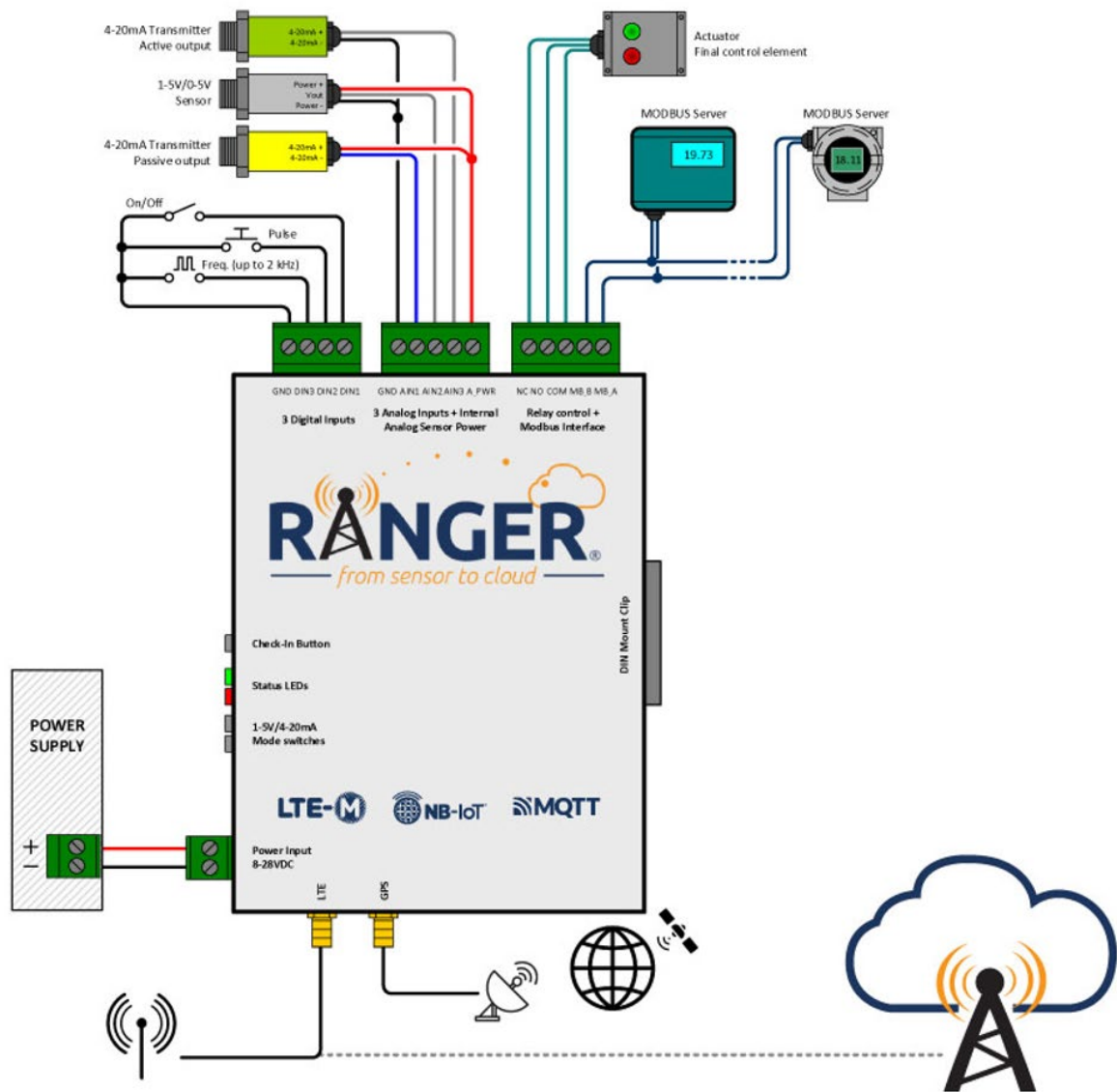

RANGER Internal components

Setup

Devices purchased with the SignalFire Cloud service come with a pre-installed SIM card. Customers will require a login to access the SignalFire Cloud server (signal-fire.cloud). Fill out the request form here: <https://signal-fire.com/lte-m1-cellular-products/cloudregister/> to setup your company site.

Adding the RANGER to your SignalFire Cloud Group

1. Apply DC power and wait 1-2 minutes so the RANGER can first connect to the cellular network
2. Verify that the RANGER is connected to the cellular network by pressing the "CHECKIN" button on the device and observe 3 strobes of the green status light.
3. Login to the SignalFire Cloud with your account login/password
4. From the Home page click "Add Device"
5. Enter the RANGER serial number and click "Claim". The serial number is located on the bottom of the RANGER with a format of "RD" followed by 6 numbers. (e.g. RD123456)
6. A message will be sent to the RANGER to claim it to your group account
7. Within approximately one minute the device will connect to your account, and you will be automatically redirected to the device status page

Sensor Connections

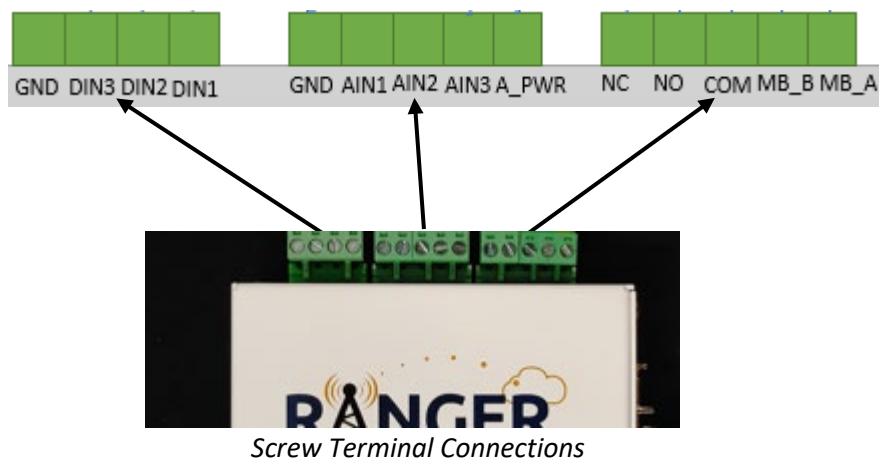

Analog Inputs

The analog inputs provide 13VDC/18VDC (selectable in software) to the attached sensor. The analog inputs, being AIN2 and AIN3, can operate in either current (4-20mA), or voltage (1-5VDC). The input mode must be set by the slide switch. Slide the switch up to **V** for a voltage input, or down to **mA** for a current input. AIN1 is set to a fixed 4-20mA mode operation.

Digital Inputs

The digital inputs (3 total) can be dry contact or voltage (must be push-pull, 30 Volts max). Be sure to connect the ground bus from the module to either the ground of the voltage pulse device or the dry contact.

Relay Output

The RANGER has a single latching SPDT relay which may be controlled remotely from the server or by using the RANGER's internal relay control logic

Modbus RS-485

The Modbus pins MB_A and MB_B provide the RANGER with the ability to read a Modbus sensor over two-wire RS-485. Sensors can be powered off the RANGER's onboard analog sensor power output pin A_PWR or powered externally. Like the analog sensor, its voltage is set in the RANGER configuration tile. The RANGER can provide up to a total of 60mA at 18VDC for all attached sensors. If more power is needed, it is recommended the sensors be powered with an external DC source. Follow the wiring diagram under *Interface Wiring* for integrated and externally powered options.

The attached sensors need to each have a unique Modbus ID.

The RANGER acts as a Modbus Client and polls data from connected Modbus Server(s) attached.

Power

The DIN Mount RANGER requires an 8-28VDC power source. The DIN RANGER requires less than 2mA of power to operate the cellular modem. The supply must be capable of supplying a peak current of 250mA which is required for cellular transmissions. If the RANGER is configured to power attached sensors, the sensor current is in addition to the RANGER modem current.

Antenna Connections

The RANGER requires that an LTE 4G cellular antenna be connected to the SMA connector labeled LTE-M. SignalFire offers a variety of cellular antennas that can be used with the RANGER.

If the GPS location feature is required a GPS antenna must be connected to the GPS SMA connector. SignalFire offers antenna options. Note that for the GPS to function the antenna need to have clear view of the sky and will not work indoors.

Sim Card Insertion

The DIN Mount RANGER requires a nano SIM card that supports LTE-M or NB-IoT service.

If the RANGER was purchased without the SIM card and data plan offered by SignalFire a compatible SIM card must be installed.

To install a SIM card first remove the four Philips head screws securing the cover. The SIM card is then inserted into the SIM slot located on the underside of the round RANGER PCB.

The image below demonstrates where the SIM card slot is located and in what orientation the sim card should be inserted.

The sim card slot is located on the bottom side of the RANGER in the area indicated by the red highlighted outline. Make sure that, from the top view, the slanted angle of the sim card is on the bottom right-hand corner as it is inserted into the RANGER's SIM card slot and the SIM card contacts are facing up

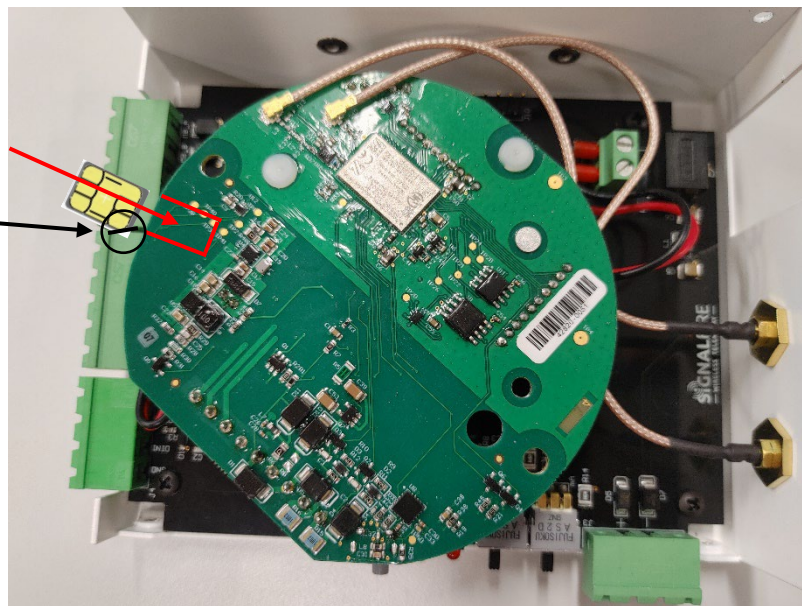

Interface Wiring

The DIN Mount RANGER contains three interfaces. These interfaces are:

- Analog (4-20mA or 1-5V)
- Discrete Input (on/off or pulse up to 2KHz)
- Relay Output
- Modbus Serial

All three interfaces require sensors that must connect to the DIN RANGER via the three top terminal sections of the DIN RANGER. The user can either use the DIN RANGER to power the connected sensor or they can be externally supplied. The images below demonstrate how each sensor should be wired if the sensors are supplied by the DIN RANGER or externally supplied.

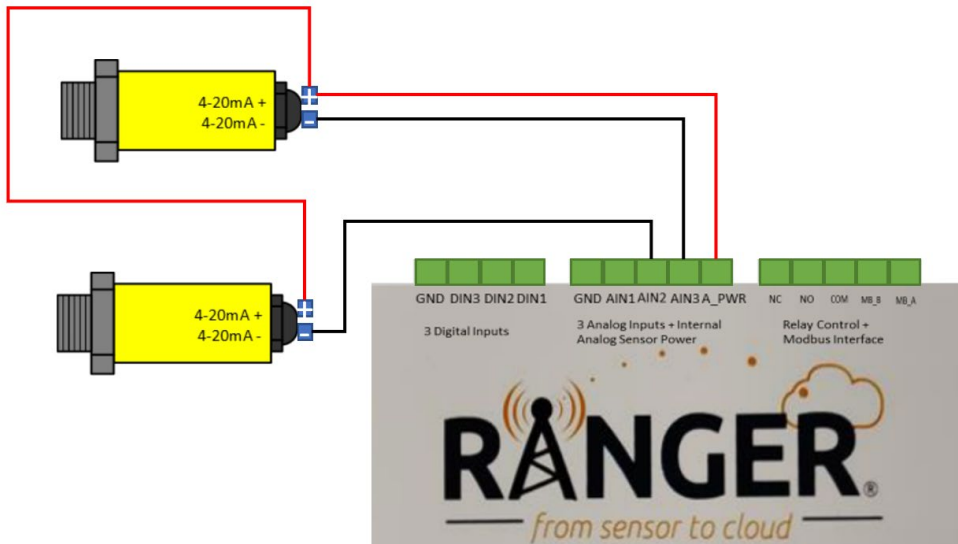

4-20mA Internal Supply Wiring

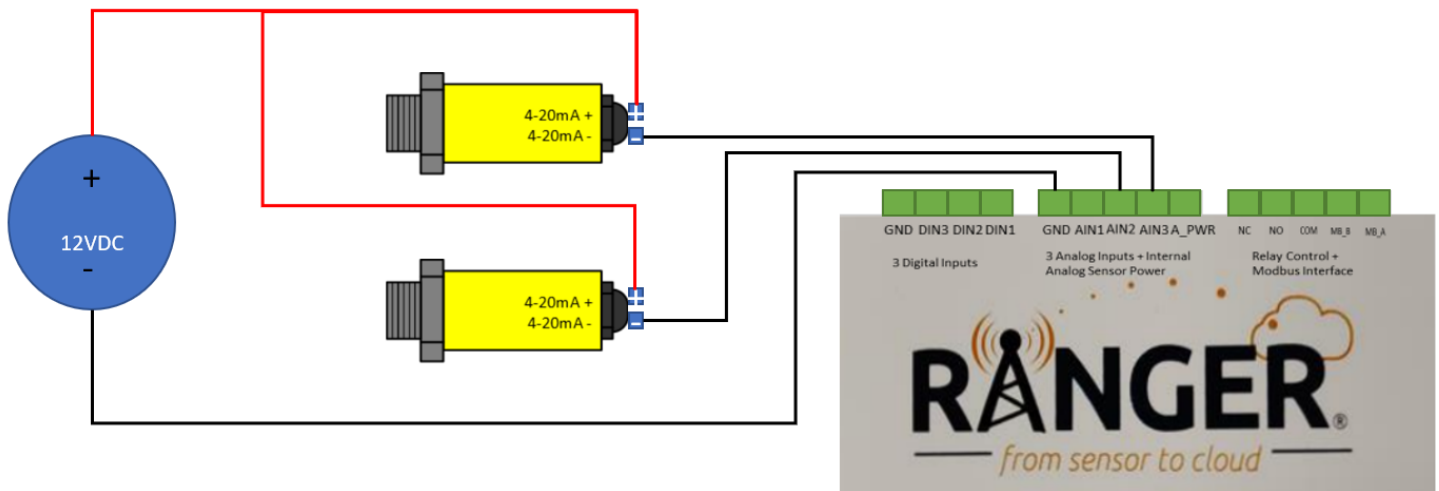

4-20mA External Supply Wiring

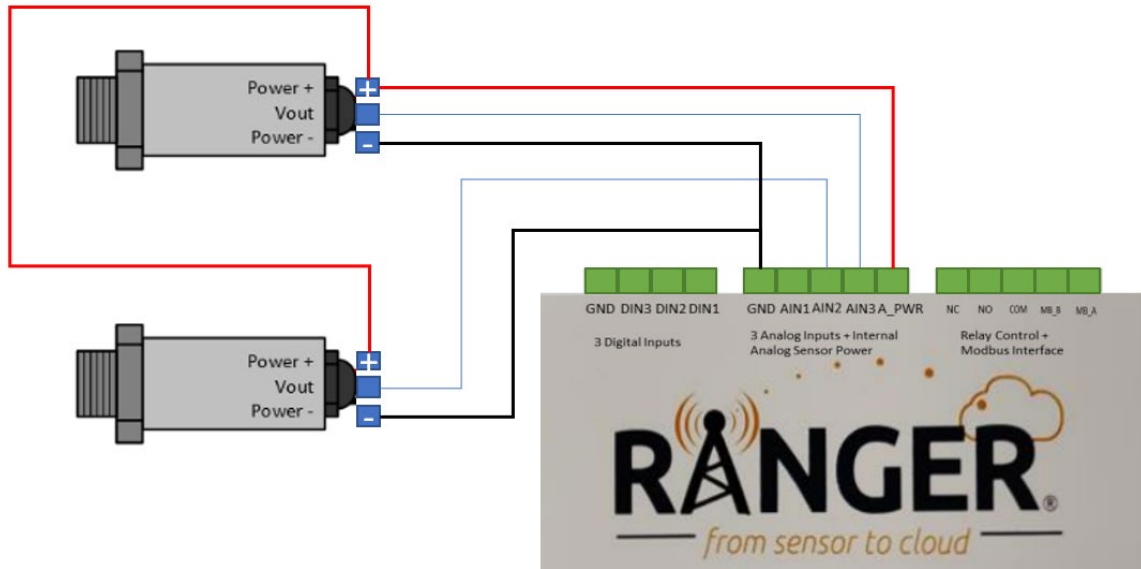

1-5V Internal Supply Wiring

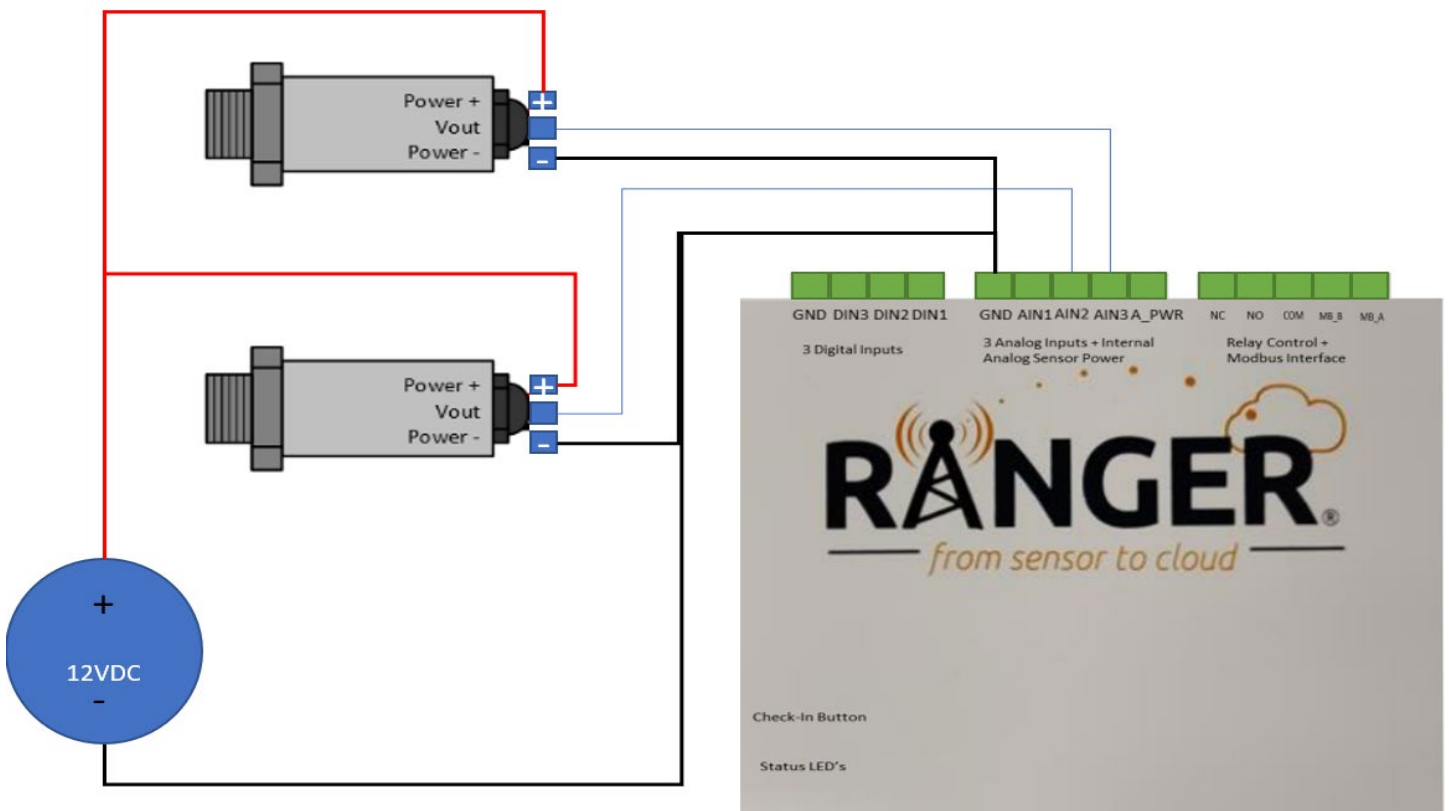

1-5V External Supply Wiring

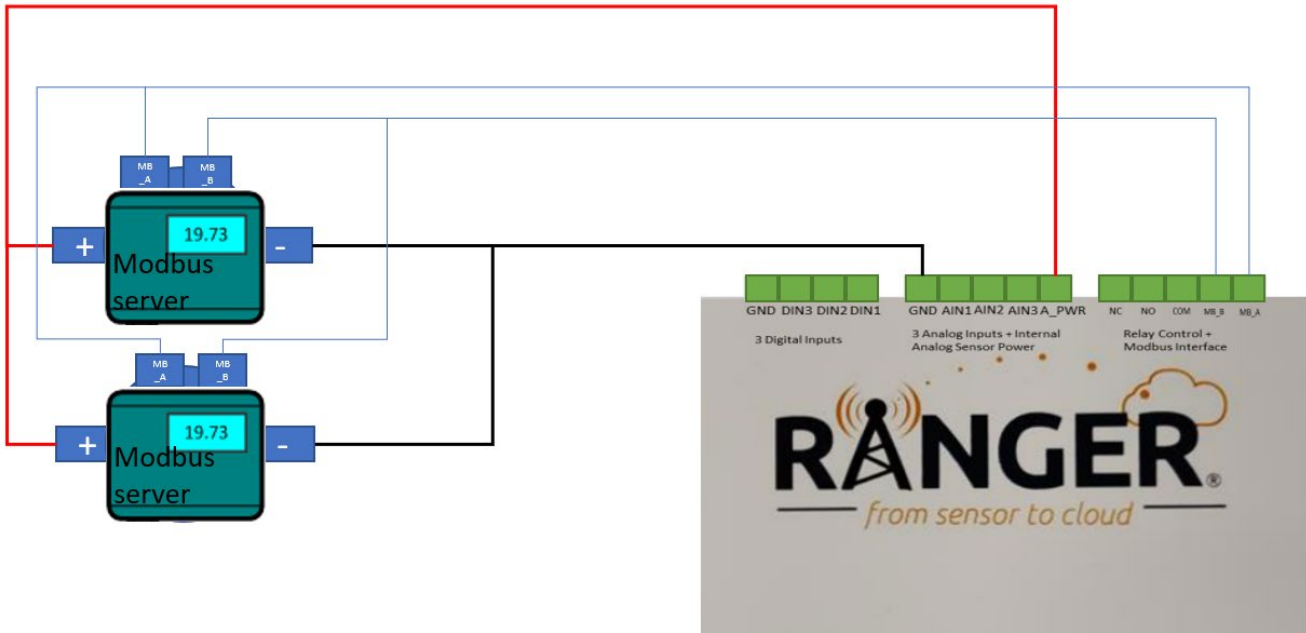

Modbus Internal Supply Wiring

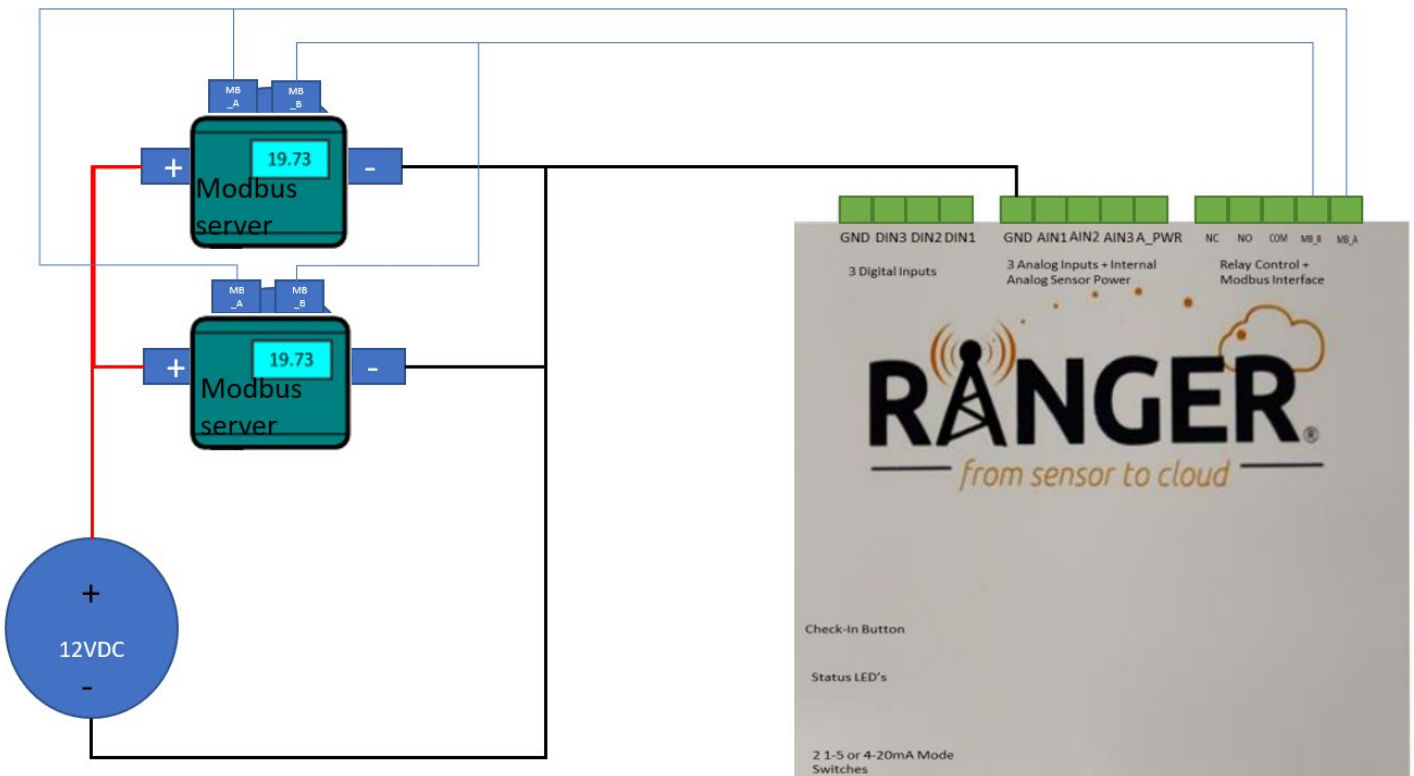

Modbus External Supply Wiring

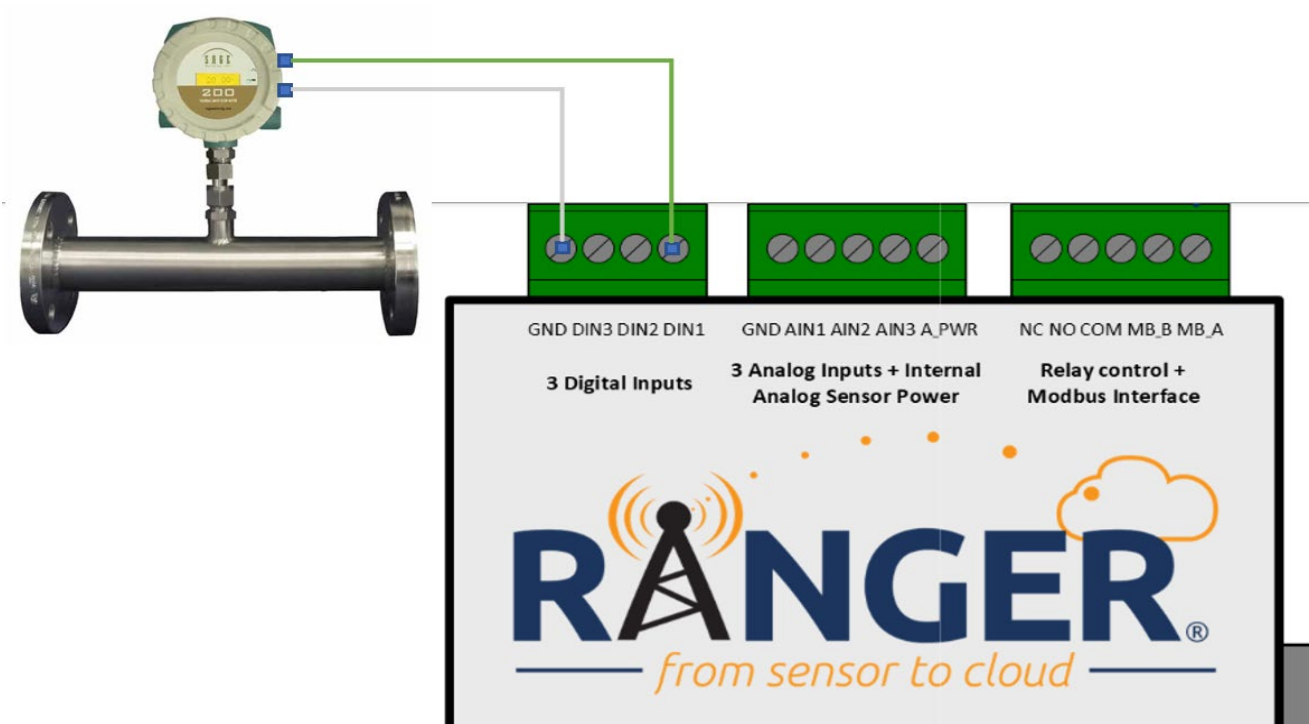

Flow Meter Wiring Using a Pulse Output into the Digital Input

RANGER Configuration

The RANGER can be configured using the RANGER ToolKit software over the micro-USB port, or via the SignalFire Cloud interface.

RANGER Settings from SignalFire Cloud

After the RANGER is added to your cloud group, select a RANGER from the list on the Home tab to see the device status, sensor readings and settings.

The detail display is organized as a "tile" view with each tile representing a specific input or function. Each tile with configurable settings has a "Configure" button that will bring up the related settings.

Node Status Tile

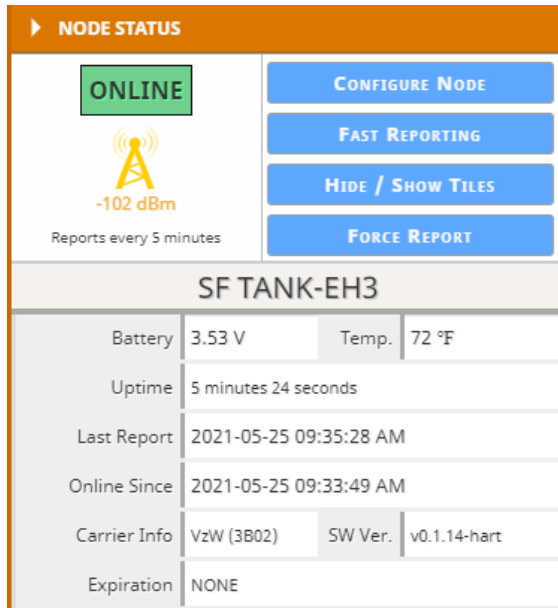

The Node Status Tile displays the following information:

- STATUS:** ONLINE (indicated by a green box)
- SIGNAL:** -102 dBm (indicated by a signal tower icon)
- REPORTING:** Reports every 5 minutes
- ACTIONS:** CONFIGURE NODE, FAST REPORTING, HIDE / SHOW TILES, FORCE REPORT
- Node Name:** SF TANK-EH3
- Battery:** 3.53 V
- Temp.:** 72 °F
- Uptime:** 5 minutes 24 seconds
- Last Report:** 2021-05-25 09:35:28 AM
- Online Since:** 2021-05-25 09:33:49 AM
- Carrier Info:** VzW (3B02)
- SW Ver.:** v0.1.14-hart
- Expiration:** NONE

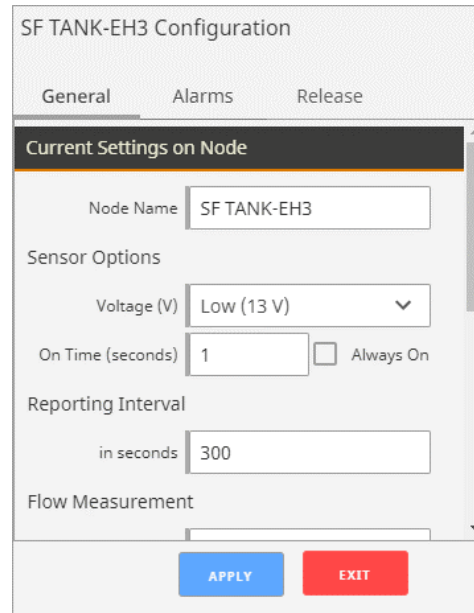

The SF TANK-EH3 Configuration screen includes the following settings:

- General:** Node Name: SF TANK-EH3
- Sensor Options:** Voltage (V): Low (13 V)
- On Time (seconds):** 1 (with an "Always On" checkbox)
- Reporting Interval:** in seconds: 300
- Flow Measurement:** (field is empty)
- Buttons:** APPLY, EXIT

The Node status tile contains general information about the RANGER and allows setting the RANGER system parameters.

Configure Node

The "Configure Node" allows for "General" settings, "Alarms" settings, and a "Release" option:
Under General:

Node Name

The Node name is a user configurable string used to easily identify the RANGER.

Sensor Voltage

Sets the output voltage applied to the analog sensor output. It is user configurable to 13V or 18V.

Sensor on Time

Configures the amount of time the Sensor Voltage is applied to the sensor prior to taking the reading. This needs to be long enough for the attached sensor to power on and stabilize, but should be minimized to optimize battery life. **If the RANGER is not powering a sensor or if the sensor is powered externally, set this value to 0. Note: sensors may vary...consult your sensor manufacturer to understand how long it takes to power on or take a measurement.**

Report Interval

The setting controls the interval at which the RANGER will apply power to the attached sensor and forward the sensor readings to the Cloud. Clicking on "Fast Reporting" will open up the Fast Reporting Interval window.

Flow Measurement

By default, the digital inputs report input state (open/closed) and input frequency. Optionally one or both digital inputs can be configured for Flow Measurement Mode. This is used for a connection to a flow meter with a pulse output and allows the user to configure a pulse k-factor and see the instantaneous flow rate, average flow, and total flow in volume units.

The analog inputs can also be used for flow measurement, where a current/voltage corresponds to a flow rate. The RANGER can sample the analog input at the report time only and do a rough approximation of a flow total by assuming that the flow rate stays constant between report samples. Note that there will always be some inaccuracy when using an analog input for flow totalization. A digital pulse is recommended whenever possible for best accuracy and low power operation.

-Under Alarms:

Offline Alarm

The RANGER will send an alarm if the device is offline for more than the configured 'Offline Threshold' setting.

Low Battery Alarm

Allows the configuration of a threshold to dictate a low battery alarm.

-Under Release:

Release

If the RANGER has been added to the wrong group and needs to be claimed under a different group, the RANGER can be released through the Release tab of the "Configure Node" window.

Ranger_Modbus_Demo Configuration

General Alarms Release

Current Settings on Cloud

EDIT ALARM GROUP

Offline Alarm

Seconds 300 Enabled

Low Battery Alarm

Level (volts) 3.0 Enabled

APPLY EXIT

Offline Alarm Setting
under the "Configure
Node" option

Fast Reporting

FAST REPORTING TRIGGERS				APPLY	EXIT
Current Settings on Node					
Metric	Value	Comparison	Threshold		
AIN1	-0.02	>	8		
None	0	N/A	0		
None	0	N/A	0		
None	0	N/A	0		
FAST REPORTING SETTINGS					
Fast Reporting is	Enabled	Current State:	Inactive		
Trigger when	Any Fast Reporting triggers are TRUE				
Remain Fast Reporting	for Fast Reporting Duration				
Fast Reporting Duration (seconds)	3,600				
REPORT SETTINGS USED WITH FAST REPORTING					
Report Interval (seconds)	60	Sensor On Time (seconds)	-1	<input checked="" type="checkbox"/>	Always On

The RANGER can be configured such that if certain inputs cross a threshold, the RANGER will temporarily update at an increased rate. Fast Reporting can trigger when one or all conditions are met and can stay on for the entire time the input(s) are above the threshold, or a set time. In the above example, if Analog Input 1 goes above 8mA, the RANGER would begin reporting its sensor values every 60 seconds, for 3,600 seconds (1 hour).

Hide/Show Tiles

This feature allows the hiding or presence of a data tile on the dashboard menu of a given RANGER node. This is done by selecting the desired data inputs and clicking on either “Hide Selected” or “Show Selected” and then selecting “Apply”.

Force Report

Causes the RANGER to take a new sensor reading and send the data to the server on its next “ping” interval. This can take up to 40 seconds.

The Alarm Group ID

Accessible by clicking on the “Edit Alarm Group” option under the “Alarms” setting, this defines which alarm group will receive alarms from this device. Each user configured in the Users tab can be assigned an alarm group number. Any users with a matching alarm group will receive alarms from this RANGER. Multiple alarm groups may be entered separated by a comma and all groups entered will receive alarms.

Analog Input Tile

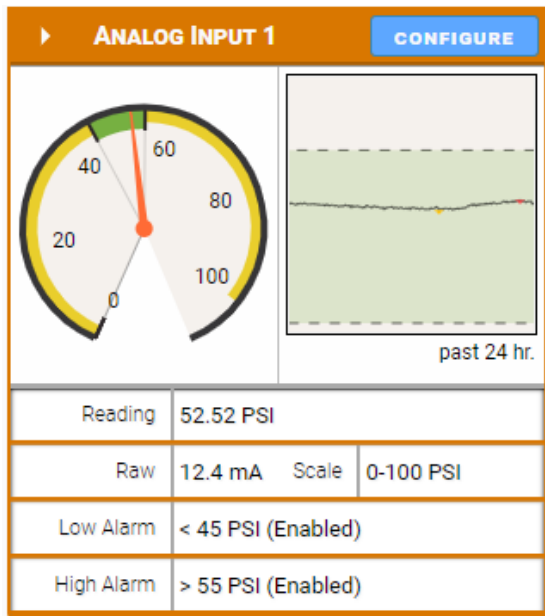

The Analog Input 1 Settings screen has three tabs: General, Alarms, and Display. The General tab is active, showing the following settings:

- Analog Mode: V
- Scale Units: PSI
- Scale Low: 0
- Scale High: 10,000

Buttons for APPLY and EXIT are located at the bottom right.

The Analog input tile displays the details for the analog input, including scaling and alarms. Since the DIN RANGER will include 3 analog inputs, each input will appear as their own Analog Input 1, Analog Input 2, and Analog Input 3 tiles, respectively.

Analog Mode

This will display the input mode (4-20mA or 1-5V) that is set by the slide switch on the RANGER.

Scale Units

This is a user definable setting to identify the engineering units.

Scale Low / Scale High

The scaling allows the user to span the analog sensor. The Scale low is the sensor value at 4mA/1V and the Scale High is the sensor value at 20mA/5V.

Alarm Thresholds

The analog input supports a high and/or low alarm threshold. This threshold is configured using the scaled engineering units. If the configured threshold is crossed and the alarm is enabled, a SMS and/or email message will be sent to each user in the alarm group of the RANGER.

Digital Input Tile

DIGITAL INPUT 1 CONFIGURE

CLOSED

State Count

past 24 hr. Average Frequency

Count	4		
Avg. Freq.	0 Hz	Inst.	0 Hz
State Alarm	Alarm on CHANGE (Enabled)		
Debounce	10 ms	Report On Change	Enabled

Digital Input 1 Settings

DIN Alarms Display

Current Settings on Node

Reset Counter

Report On Change

Debounce Delay (ms)

APPLY EXIT

There is a Digital Input tile for each of the three digital inputs, Digital Input 1, Digital Input 2, and Digital Input 3 unless they are configured for Flow Mode. If a digital input is configured for Flow Mode, the flow totalizer tile will replace the Digital Input tile. It will appear as Digital Input 3 tile.

Reset Counter

Selecting this check box and click apply will zero the input cycle count.

Report on Change

If selected, the RANGER will report any changes on state of the input to the Cloud within 2-seconds rather than waiting until its next scheduled report.

DIN Alarm

The RANGER can send an alarm when the DIN opens, closes or on any change.

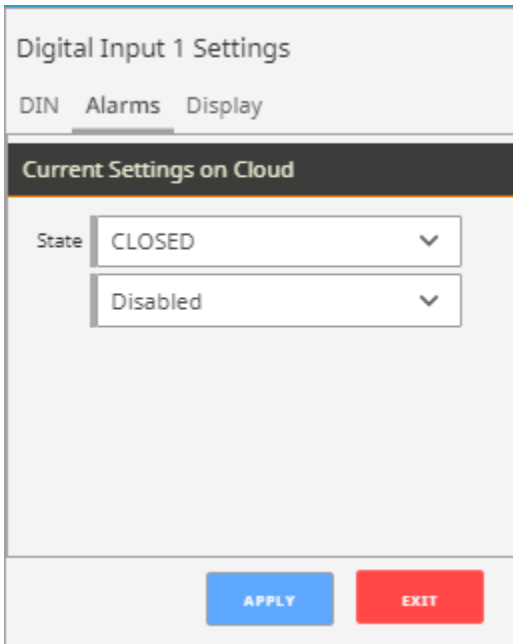

Digital Input 1 Settings

DIN Alarms Display

Current Settings on Cloud

State: CLOSED

Disabled

APPLY EXIT

This screenshot shows the 'Alarms' tab of the 'Digital Input 1 Settings' interface. It features a dark header with the title 'Current Settings on Cloud'. Below this, there are two dropdown menus: the first is labeled 'State' and is set to 'CLOSED', and the second is labeled 'Disabled' and is set to 'Disabled'. At the bottom of the form, there are two buttons: a blue 'APPLY' button and a red 'EXIT' button.

DIN Display

The DIN "Display" setting presents several configurable settings with respect to the digital input IO's. For instance, the name of the IO, the truncated name, and preferred name changes to when the digital input is open or closed.

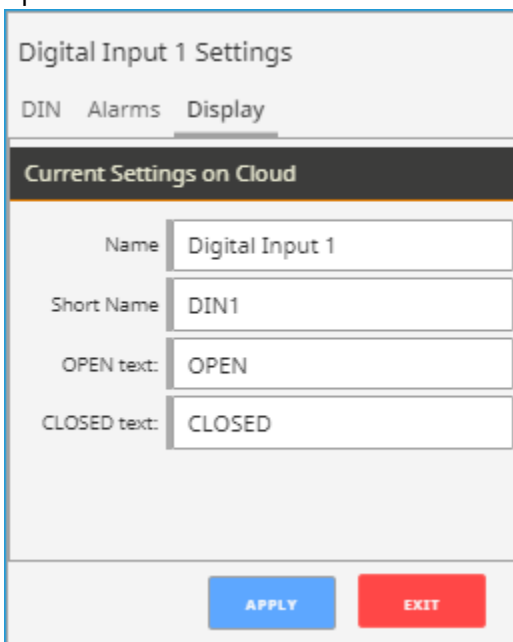

Digital Input 1 Settings

DIN Alarms Display

Current Settings on Cloud

Name: Digital Input 1

Short Name: DIN1

OPEN text: OPEN

CLOSED text: CLOSED

APPLY EXIT

This screenshot shows the 'Display' tab of the 'Digital Input 1 Settings' interface. It features a dark header with the title 'Current Settings on Cloud'. Below this, there are four text input fields: 'Name' (containing 'Digital Input 1'), 'Short Name' (containing 'DIN1'), 'OPEN text:' (containing 'OPEN'), and 'CLOSED text:' (containing 'CLOSED'). At the bottom of the form, there are two buttons: a blue 'APPLY' button and a red 'EXIT' button.

DIN Flow Totalizer Tile

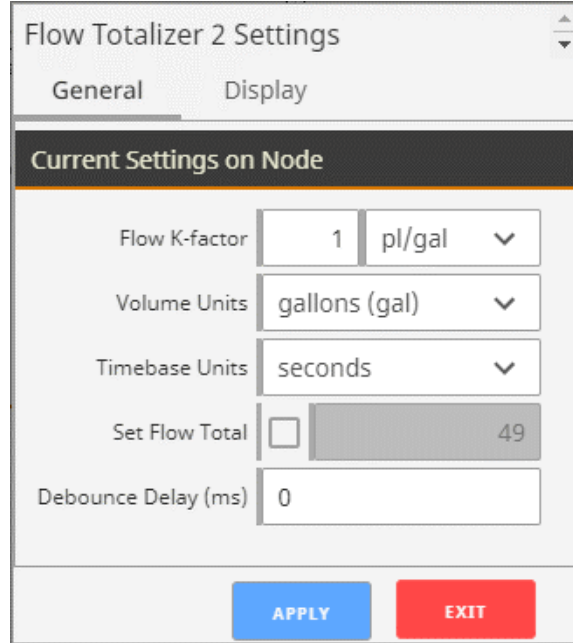
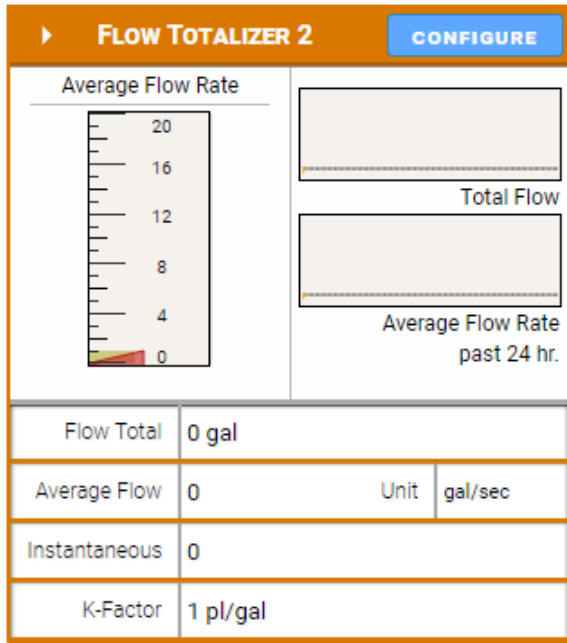

If a digital input is configured for Flow Mode, the flow totalizer tile will replace the default Digital Input tile. As mentioned previously, when in flow mode the RANGER will display the flow rate and total flow volume. The Average Flow is the average flow rate over the configured RANGER Report Interval, while the Instantaneous Flow rate is the flow rate calculated over the 2 seconds immediately before the report.

Flow K-Factor

For the Flow K-Factor, select the desired volume pulse units. Enter the number of pulses per unit volume that the flow meter outputs.

Volume Units

The Volume Units is used to select the volume units needed for the flow rate and total volume calculations.

Timebase Units

The Time base units select the time units for the flow rate calculations.

Set Flow Total

This allows the user to set or reset the total volume measured. Click the checkbox then enter the volume.

Total Units VS. Flow Rate Units

When Flow Measurement is enabled, make note that, within the Return Flow Settings, total units can be set independently of the flow rate units:

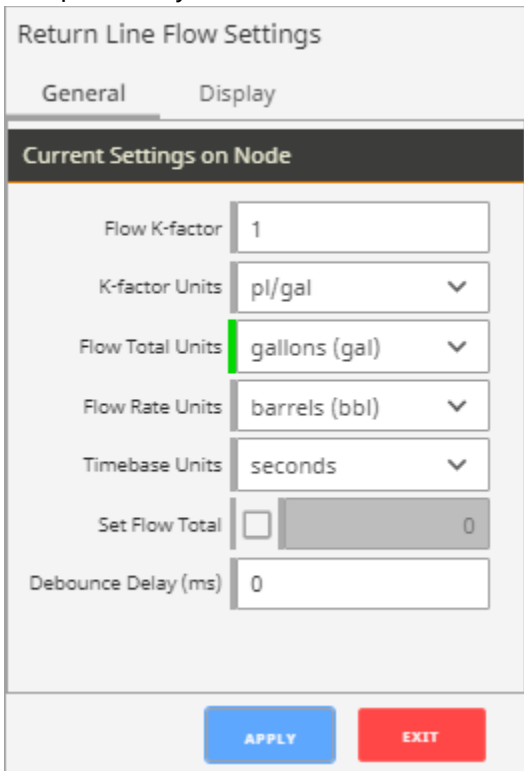

The screenshot shows the 'Return Line Flow Settings' interface. It has two tabs: 'General' and 'Display'. Under the 'General' tab, there is a section titled 'Current Settings on Node'. The settings are as follows:

Flow K-factor	1
K-factor Units	pl/gal
Flow Total Units	gallons (gal)
Flow Rate Units	barrels (bbl)
Timebase Units	seconds
Set Flow Total	<input type="checkbox"/> 0
Debounce Delay (ms)	0

At the bottom of the form are two buttons: 'APPLY' (blue) and 'EXIT' (red).

GPS Tile

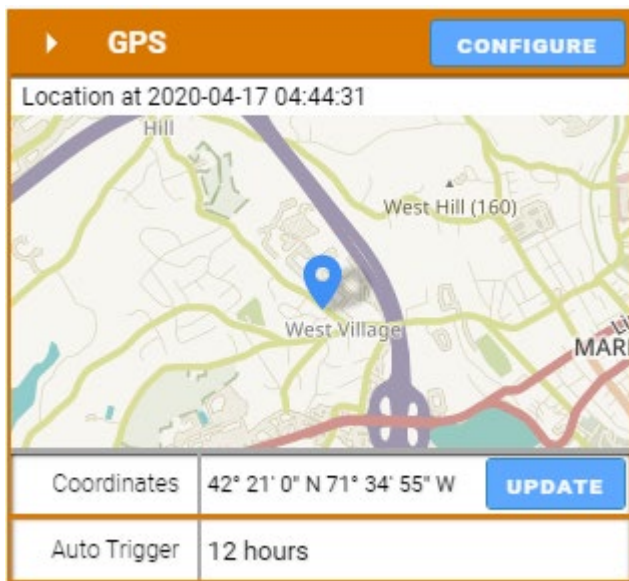

The screenshot shows the 'GPS' tile interface. At the top, there is a 'GPS' header with a right-pointing arrow and a 'CONFIGURE' button. Below the header, it displays the location: 'Location at 2020-04-17 04:44:31'. The main area is a map showing a location near 'West Hill (160)' and 'West Village'. Below the map, there is a table with the following data:

Coordinates	42° 21' 0" N 71° 34' 55" W	UPDATE
Auto Trigger	12 hours	

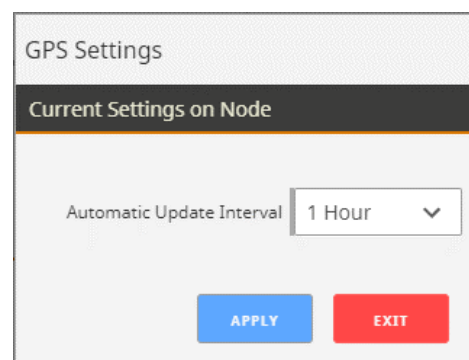

The screenshot shows the 'GPS Settings' interface. It has a section titled 'Current Settings on Node'. The settings are as follows:

Automatic Update Interval	1 Hour
---------------------------	--------

At the bottom of the form are two buttons: 'APPLY' (blue) and 'EXIT' (red).

The RANGER has an internal GPS receiver/antenna to provide location data to the server. The RANGER requires a clear view of the sky for the GPS functionality. GPS to function. The GPS will often not work inside even if the RANGER is near a window.

A GPS update may be triggered on demand, or an automatic location update interval between 1 and 12 hours can be configured. For an on-demand location update, click the "UPDATE" button. Note that an initial "cold" GPS fix may take up to 5 minutes.

While the GPS receiver is active commands sent to the RANGER may take up to 80 seconds to be delivered.

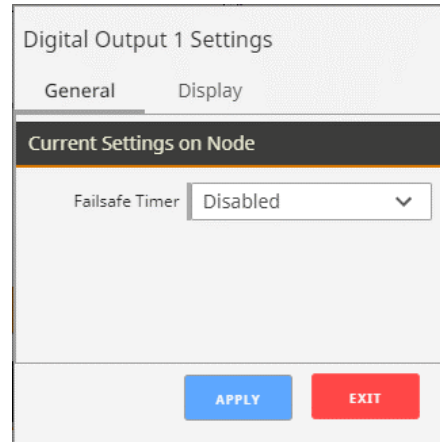
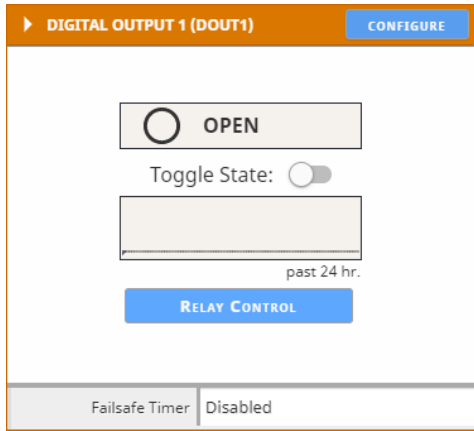

The relay output can be toggled by setting the Toggle State switch. The command will reach the RANGER on its next “ping” interval which can take up to 40 seconds. The Toggle State switch will change to blue and the OPEN/CLOSED indicator will change once the message has reached the RANGER.

The relay output also has an optional failsafe timer. If this is configured, the relay will go to the open (failsafe) state if the RANGER loses connection to the server for the configured time.

Relay Control

The digital output on the RANGER can be configured to energize and de-energize based on its other inputs. This control logic is run locally in the RANGER and does not depend on cellular connectivity. First, the “Relay Control” field should be Enabled. The trigger logic can be entered by specifying which input to control the relay from, and then specifying which values of that input energize and de-energize the relay.

If the relay is being triggered from multiple inputs, the user can select whether all the triggers need to be true (Boolean AND), or any of the triggers need to be true (Boolean OR). The Minimum Energize Time field determines the amount of time the relay, once energized, will stay on even if the de-energize condition becomes true.

RELAY CONTROL TRIGGERS: SF TANK-EH3					
Metric	Value	Energize When	Threshold	De-energize When	Threshold
DIN1	0	=	0	=	1
DIN2 Avg Hz	0	>	20	<=	18
None	0	N/A	0		0
None	0	N/A	0		0
None	0	N/A	0		0
None	0	N/A	0		0
None	0	N/A	0		0
None	0	N/A	0		0

RELAY CONTROL SETTINGS	
Relay Control is	Enabled
Energize Relay when	Any Relay Control triggers are TRUE
Minimum Energize Time (seconds)	1
Current State:	Active
Failsafe Enabled (Missing Source data sets trigger to de-energize)	<input type="checkbox"/>

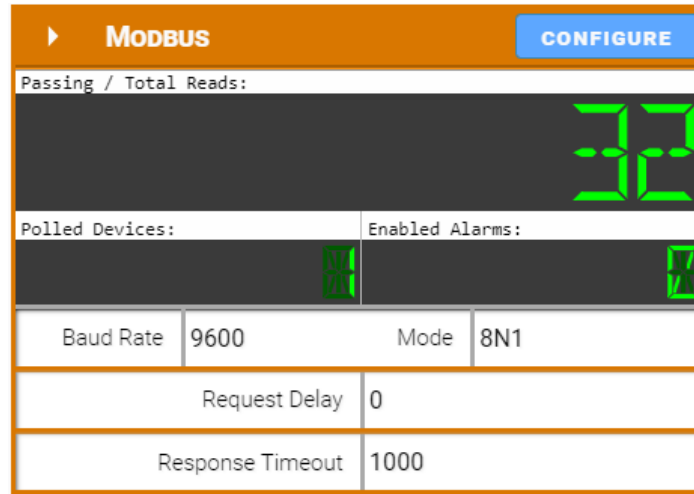

If the RANGER has the Modbus expansion card installed, users can configure the RANGER to read Modbus registers from any attached sensors. To set the RS-485 communication parameters and configure Modbus reads, click on the “Configure” button on the Modbus tile.

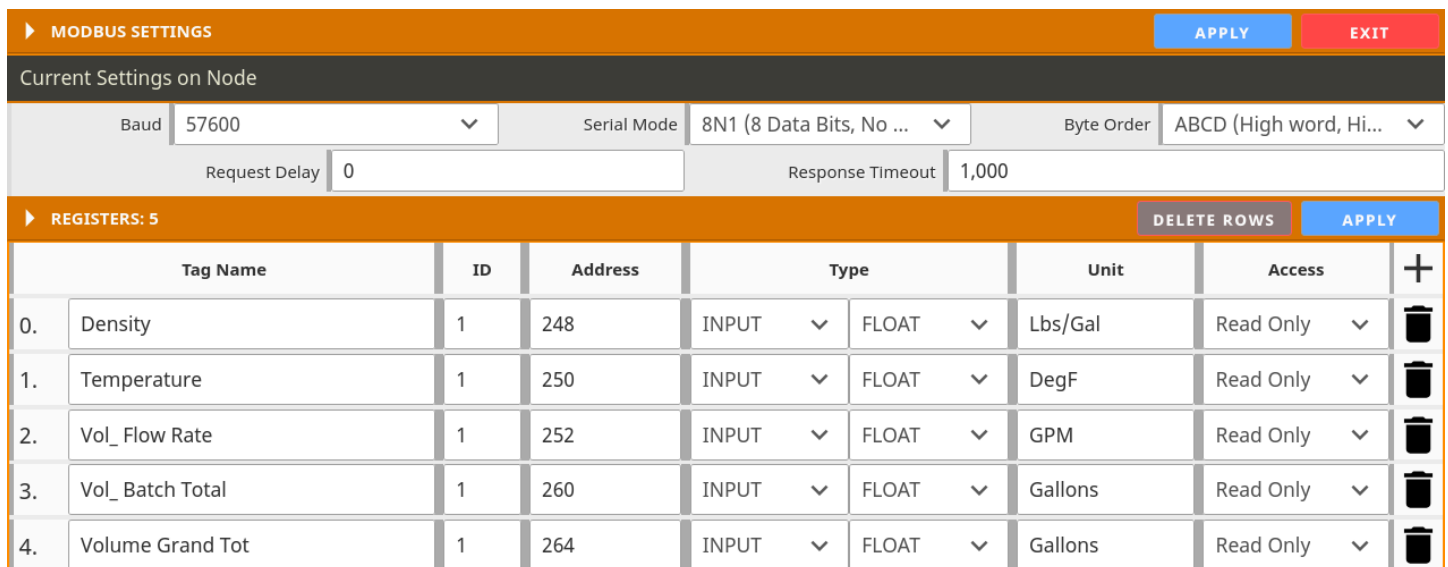

Use the top portion of the menu to configure communication parameters. These settings must match all the sensors on the RS-485 multidrop network. The default configuration is shown in the figure above.

The RANGER can read up to 32 datapoints from up to 8 connected devices. To add a new register read, click on the '+' button. Each line needs to be specified with a Tag Name, and point to a Modbus Slave ID, register type, register address, register data type (INT16, UINT16, INT32, UINT32, INT64, UINT64, FLOAT, DOUBLE, or BIT), and read/write access. The register can also be tagged with units if needed. Click Apply to send the changes to the RANGER.

The RANGER can read individual bits of a 16-bit register. This can be useful for bitmask registers where each bit position represents a flag/status alarm. To select the bit, change the Type to "Bit Pos" and then the bit position number. Bit Pos 0 reads the Least Significant Bit, and Bit Pos 15 reads the Most Significant Bit of a 16-bit register.

To select lines for deletion, click on the trash can icon at the end of each line, and then click on the "Delete Rows" button to delete all the rows selected.

Once the registers have been set up as desired and applied, click "Exit" to return to the RANGER's main page. The registers and their values will appear in a table below, where they can be organized in ascending or descending order by clicking on each header. The Modbus register configuration can also be done locally using the RANGER ToolKit.

Tag Name	Value	Units	Status	Alarm Low	Alarm High	Configure	Enable View History	Enable Custom Tile
Density	0.001 Lbs/Gal	Lbs/Gal	✓ Passing	0.0 (DISABLED)	0.0 (DISABLED)	MODIFY	<input type="checkbox"/>	<input type="checkbox"/>
Temperature	69.112 DegF	DegF	✓ Passing	0.0 (DISABLED)	0.0 (DISABLED)	MODIFY	<input checked="" type="checkbox"/>	<input type="checkbox"/>
Vol_Batch Total	0 Gallons	Gallons	✓ Passing	0.0 (DISABLED)	0.0 (DISABLED)	MODIFY	<input type="checkbox"/>	<input type="checkbox"/>
Vol_Flow Rate	0 GPM	GPM	✓ Passing	0.0 (DISABLED)	0.0 (DISABLED)	MODIFY	<input type="checkbox"/>	<input type="checkbox"/>
Volume Grand Tot	91,164.875 Gallons	Gallons	✓ Passing	0.0 (DISABLED)	0.0 (DISABLED)	MODIFY	<input type="checkbox"/>	<input type="checkbox"/>

Clicking on the slider for "Enable View History" will add that register to the historical data view at the bottom of the page. Clicking on "Modify" will bring a pop-up to configure alarms, or to do a register write to set a Modbus value in a register. Every register can be individually set up with Low and High alarm thresholds. Click "Apply" to save alarm settings for each register.

FLOAT 1 APPLY

Current Settings on Node

Register Value: 700.553100

ALARMS APPLY

Current Settings on Cloud

Low Alarm Threshold	0	Disabled
High Alarm Threshold	0	Disabled

Clicking on the slider for "Enable Custom Tile" will make that metric viewable as a tile similar to the analog and digital inputs.

MODBUS RPM CONFIGURE

Reading: 1532

Low Alarm: < 0.0 (Disabled)

High Alarm: > 0.0 (Disabled)

MODBUS TEMP 1 CONFIGURE

Reading: 42.1669998169

Low Alarm: < 0.0 (Disabled)

High Alarm: > 0.0 (Disabled)

MODBUS RUN STATUS CONFIGURE

Reading: 1

Alarm value: 0 (Disabled)

Historical Data View

27

The server maintains a database containing the historical data view of all reported readings. The data may be viewed as a graph or a table view. Select which data values to display and the time range to view. The selected data for the configured time interval may be exported to a .csv file by clicking the "Export" button.



Default View

A user can configure the default trend view they which to see when they open the view for a RANGER. Simply configure the desired data to display and the desired default time display and click the "Set as Default" button. This view will be saved and be the default view for your account for that RANGER device.

Users can create custom dashboards that can display data from multiple RANGERS on a single dashboard. Within each dashboard users can create groups to logically group data views. To create or edit a dashboard the user must have "Dashboard Admin" rights on their account.

Create Dashboards and Data Groups

1. Select the "Dashboards" menu item, then click "Manage Dashboards" and then click "Add a Dashboard" and enter a name for the custom dashboard and click the "Rename" button to save.
2. Click the "+ Add Data Group" button to create your first data group and click the edit button to edit this group.
3. Name the data group and click the "rename" button to save. Each dashboard can have multiple data groups

Add data points to Data Group

In each data group users can add data points one at a time or in bulk.

To add a single data point, click the "Add Data Point" button. From here select the RANGER, metric and then the display type. The options for display type will vary depending on the metric type. Options include the Device Tile which mirrors the tiles on each RANGER detail page, additionally there are other simple data views like a gauge, tank alarm status icon, or value display.

Each tile will have a title bar indicating the RANGER name along with the RANGER connectivity status.

If you want to add the same data point from multiple RANGERS to a data group, click the "Bulk Add Data Points" button. Select multiple RANGERS in the select device list by holding the Ctrl key. Once one or more RANGERS is selected, a list of common metrics will be displayed in section. Select a metric then select the display type and click Save to Data Group to apply changes.

Add Data Points to Data Group: Sample Data Group

1) Select one or more devices

- 352656100597312 [RA000000]
- 352656100923278 [RA000060]
- 352656102536243 [RA001460]
- Josh Rev 2.0 Test [I751931]
- Josh Test Ranger [I597486]
- RP A2D1 [RA000006]
- RP HART [RA000005]
- RP MODBUS [RA000004]
- RP Modbus 96 [RA000566]
- RP PRESSURE [RA000003]
- RP Rev2 [I751998]
- RP SDI-12 [RA000007]

2) Select a metric common across selected devices

- Analog Input 1
- Digital Input 1
- Digital Input 1 Count
- Digital Input 1 Average Frequency
- Digital Input 1 Instantaneous Frequency
- Digital Input 2
- Digital Input 2 Count
- Digital Input 2 Average Frequency
- Digital Input 2 Instantaneous Frequency
- Digital Input 3
- Digital Input 3 Count
- Digital Input 3 Average Frequency

3) Select a display type

- Device Tile
- 24 Hour History
- Alarm Indicator
- Value Reading
- Dial Gauge
- Tank Gauge

Save to Data Group

Go back to Data Group

Example of bulk adding datapoints

Users

A SignalFire Cloud account is necessary to have access to your company's RANGERS. Contact your company's Cloud user admin to set up your account. If your company does not have an account and you are performing first time setup, complete the form at <https://signal-fire.com/lte-m1-cellular-products/cloudregister/> to request a new user account group.

User Settings

Once logged in, select your username in the upper right to change your user settings. Enter your contact phone number and/or email address and enable Alarms to have alarm notifications sent to you. Enable billing to receive reports on which RANGERS are about to expire and need to have their Cloud subscription renewed. After making changes (highlighted in yellow), click Save or Undo to apply or revert the changes made.

User Settings: signalfire

First Name

Last Name

Alarm Group ID

Alarm Message Timezone Current time: 20:24:46 UTC

SMS # Alarms

E-mail Address Alarms Billing
 Alarm emails will be sent from ignition-noreply@signal-fire.com, please add this email address to your whitelist.

User Roles

<input type="checkbox"/>	User Admin
<input checked="" type="checkbox"/>	Device Admin
<input checked="" type="checkbox"/>	Alarm Admin
<input checked="" type="checkbox"/>	Alarm Ack
<input type="checkbox"/>	Report Admin
<input type="checkbox"/>	Dashboard Admin
<input type="checkbox"/>	Power Chart Admin

User Roles

All users in the group can view any RANGER, but their ability to change settings can be restricted by their user roles. There are five user roles: User Admin, Device Admin, Alarm Admin, Alarm Ack, and Report Admin.

User Admin – Can add, edit, and remove users in the user group, including changing other users' permissions. The User Admin cannot view anyone's password, but they may reset the password for a user who forgets theirs. It is recommended to restrict the number of users with this permission to as few people as possible.

Device Admin – Can add, edit, and remove RANGERS in the user group, toggle the relay output and initiate firmware updates. Note that device admins can change any settings in any RANGER without restriction.

Alarm Admin – Can configure just the alarm settings for RANGERS and users.

Alarm Ack – Can acknowledge active alarms.

Report Admin – Can add, edit, and remove automated reports.

Dashboard Admin – Can create and edit custom dashboards. All users can view created dashboards

Power Chart Admin – Can create and edit Power Charts. All users can view Power Charts

User View

31

A list of users in the group can be viewed by clicking on the Users icon in the top menu. User Admins will be able to edit any user by clicking on the "Edit User" button. This will bring up the same User Settings as shown above, with an additional option to delete the user.

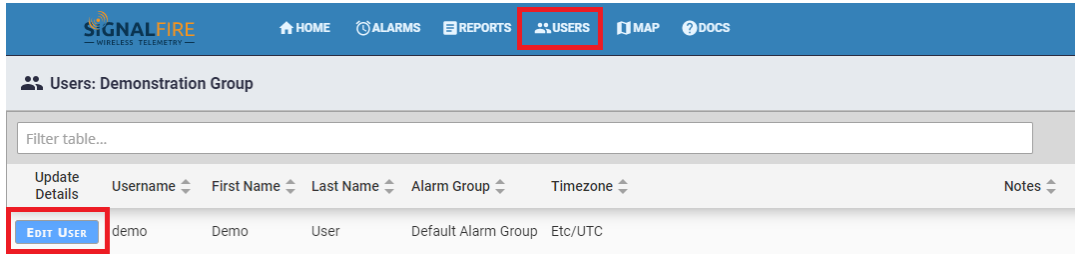

Adding Users

User Admins may add additional users in the User view by clicking Add User in the upper right-hand corner. Fill in the fields, configure permissions, and click "Create". A window will pop up with a temporary password for the new user once complete. It is recommended that an email address is used for the username so it is unique.

The screenshot shows the "Create New User" form. It has a title bar with a user icon and the text "Create New User". The form contains the following fields and options:

- Username:
- First Name:
- Last Name:
- Alarm Group:
- Timezone: Current time 16:49:38 EDT
- User Roles:

At the bottom of the form are two buttons: "CREATE" and "CANCEL".

Alarms

The SignalFire Cloud provides a robust and flexible system that allows users to be notified by email and/or text message when a specified metric from a RANGER enters and clears an alarm state. The alarms can be set up so only certain users get alarms for certain RANGERS with the alarm group function.

To enable an alarm on an account with the Alarm Admin role, go to the RANGER, click “Configure” on the tile for the metric that you’d like to trigger an alarm on, and set its alarm threshold through the Alarms tab. The screenshot below shows the Configure window for Analog Input 1. If Analog Input 1 goes below 6mA or above 18mA, an alarm notification will go out to every user subscribed to this RANGER’s alarms. A user with Alarm Ack permissions may acknowledge the alarm to signal that the alarm and/or its cause have been taken care of. Unacknowledged alarms can be seen accumulated in the upper right-hand corner of the Cloud page.

Analog Input 1 Settings

General Alarms Display

Press Apply to set values

Alarm Thresholds





Low	6	Enabled	▼
High	18	Enabled	▼

APPLY EXIT

Alarm Views

Clicking on the Alarms button in the top bar will open a table of all alarm trigger events. The list of events can be sorted in ascending or descending order by any of the display columns by clicking on the column name.

The Alarm Status view contains the current state of the alarm system, while the Alarm Journal contains a history of all alarm events. Both the status and journal alarm tables can be exported to a csv file.

The upper-right hand corner of the table contains a gear  icon, sort  icon, and search  icon that help filter and find alarm triggers. The gear icon is used to enable/disable the display columns used for ascending/descending sort. The sort icon is used to filter alarms by their cleared/acknowledge state. The search icon is used to search alarms by keyword in any of its enabled columns. For example, if there is a RANGER named “Tank 6R” and the name column is enabled, typing in “Tank 6R” will show all alarm events from that RANGER. Hovering the mouse over a line will show a  icon. Clicking on it will reveal a detailed view for that alarm.

State

RANGER alarms, once triggered, can be in one of four states: “Active, Unacknowledged”, “Active, Acknowledged”, “Cleared, Unacknowledged”, and “Cleared, Acknowledged”. Active means that the alarm still

meets the alarm trigger criteria, while Cleared means it no longer does. Unacknowledged means that the alarm has not been dismissed by someone with Alarm Ack privileges, while Acknowledged means a user had seen and acknowledged the alarm.

For example, a digital input set to flow mode may have an alarm set to trigger when the average flow rate goes above 15 gallons/sec. When that threshold is first crossed, the alarm will appear in the Alarms table as “Active, Unacknowledged”. If the average flow rate goes down to 12 gallons/sec, the state will change to “Cleared, Unacknowledged”. Once an Alarm Ack user acknowledges the alarm, the state will change to “Cleared, Acknowledged”. In other words, the inputs control the Active/Clear state, while users control the Unacknowledged/Acknowledged state.

To Acknowledge an alarm, a user with the Alarm Ack user role must click on the alarm and click “Acknowledge” in the bottom right corner. A user may alternatively select “Shelve”, which prevents the alarm from triggering for a time period.

The screenshot shows the SignalFire Alarms page. The top navigation bar includes links for HOME, ALARMS, REPORTS, USERS, MAP, DOCS, DASHBOARDS, and CHARTS. The user is logged in as SIGNALFIRE and has 1 ALARM. The Alarms page has tabs for Alarm Status, Alarm Journal, Configure Alarms, and Alarm Groups. The Alarm Status tab is active, showing 1 ACTIVE alarm. The table below has columns for Active Time, Display Path, State, and Label. The first row shows an alarm from 03/03/2022 14:40:58, labeled 'Ranger Demo', with a state of 'Active, Unacknowledged' and a label of 'Analog Input 1 HIGH'. The table footer indicates 25 rows and 1 total alarm.

Active Time	Display Path	State	Label
03/03/2022 14:40:58	Ranger Demo	Active, Unacknowledged	Analog Input 1 HIGH

Configure Alarms

Users may also edit alarm settings by clicking on “Configure Alarms” in the tab list of the Alarms page. This view shows all possible alarm sources on all possible devices in the user group. The interface on the right side can be used to filter which devices, input types, and alarm groups show up in the table. This interface provides a convenient way of modifying alarms across multiple RANGERS and multiple types of alarms.

For example, clicking on Select Devices will pull up a list of all devices available. Select the RANGERS to filter by and click “Select” to add it to the list. Hold the Ctrl key as you click to select multiple at a time, or the Shift key to select a range. Once you have all the devices you’d like to see on the Included Devices list, click View Selected. Click “Clear Filter” to view all devices again.

Device	Alarm	Type	Current Value	Setpoint	Deadband
Ranger Demo	BATTERY LOW	Low Alarm	3.561904	3	0
Ranger Demo	Flow Totalizer 1 Total HIGH	High Alarm	0.271136	0	0
Ranger Demo	Flow Totalizer 1 Average Flow Rate HIGH	High Alarm	0	0	0
Ranger Demo	Flow Totalizer 1 Average Flow Rate LOW	Low Alarm	0	0	0
Ranger Demo	Flow Totalizer 1 Instantaneous Flow Rate HIGH	High Alarm	0	0	0
Ranger Demo	Flow Totalizer 1 Instantaneous Flow Rate LOW	Low Alarm	0	0	0
Ranger Demo	Digital Input 2	Digital Alarm	<input type="checkbox"/>	<input checked="" type="checkbox"/>	0
Ranger Demo	Digital Input 2 Average Frequency HIGH	High Alarm	0	0	0
Ranger Demo	Digital Input 2 Average Frequency LOW	Low Alarm	0	0	0
Ranger Demo	Digital Input 2 Count HIGH	High Alarm	0	0	0
Ranger Demo	Offline Alarm	Digital Alarm	<input checked="" type="checkbox"/>	<input type="checkbox"/>	0
Ranger Demo	Analog Input 1 HIGH	High Alarm	7.858577	7	0

34

To change a field, double click the field, enter the desired value, and then press the Enter key. Fields that have been edited but not set will be highlighted yellow. Clicking cancel will undo the yellow highlighted fields. Once all fields have been edited as needed, click the green Apply button in the upper-right hand corner. The yellow highlighted fields will change to green to indicate the changes have been set.

For a digital input, if the setpoint column is checked off that means the alarm will trigger when that input is Close or logic 1. For analog alarms, it sets the high or low threshold value depending on if it's a High Alarm type or Low Alarm type.

The **Deadband** column changes the Clear threshold for an analog alarm. As an example, if the high alarm level is 4,000, and the deadband is 200, after the analog input has gone above 4,000 and activated the alarm, it will have to go below 3,800 for the alarm to clear. Similarly, if the low alarm is 2,000 and the deadband is 200, the input will have to go above 2,200 to clear an active low alarm. This setting is useful to prevent multiple alarms when a reading is at the alarm threshold.

The **Delay** column adds a countdown timer to the alarm that starts once the threshold has been crossed. If the input stays past the threshold for entire duration of the Delay countdown, the alarm becomes active and alert messages are sent out. However, if the RANGER reports a reading below the threshold during that countdown, the timer is reset, and the threshold must be crossed again for the countdown to start again. **The Delay value should be greater than the RANGER's report interval** so there's at least one new reading before the countdown ends.

The Delay timer takes the Deadband value into consideration. Consider the previous example where the high alarm threshold is 4,000 and the deadband is 200, but now there is a 120 second Delay. Once the RANGER reports a reading above 4,000, a 120 second countdown begins. If the RANGER reports a reading of 3,900 before the timers hits 0, the alarm still activates because it's within the deadband. If it instead goes to 3,700,

the timer is reset and the input has to go back above 4,000 for the Delay timer to count down again.

Alarm Groups

When alarms are triggered, the Cloud sends messages out to users based on alarm groups. Click on the "Configure Groups" button in the upper-right corner of the Alarms tab to edit user and RANGER alarm groups. **Only users with Alarm Admin privileges may edit settings here.**

New users and newly added RANGERS will be assigned to the Default Alarm Group, which cannot be removed or renamed. To add a new group, click on the "+ New" button in the Groups tab, and then rename it in the Name field. To select which RANGERS you'd like to have in the group, click on the Configure button, check off the desired RANGERS, and click Apply.

To add a single RANGER to multiple groups at once, go to the RANGERS tab, click on the RANGER, check off the groups to add it to in the panel on the right, and click Apply. When any of that RANGER's alarms become active or clear, the Cloud will send messages to every user in the groups the RANGER is a part of.

To edit each user's group, click the Configure button to bring up a list of all users. You may then one-by-one edit which single group a user is assigned to. **Users may only be assigned to a single group.**

Configure Rangers in Alarm Group

Alarm Group: Alarm Group 2

Press Apply to set values

Name	In Group
SignalFire-Lab Rev 1.2 (AT&T) [I604589]	<input type="checkbox"/>
RA000497 [RA000497]	<input type="checkbox"/>
SF TANK-EH3 [I604480]	<input checked="" type="checkbox"/>
352656100817868 [I817868]	<input type="checkbox"/>
SignalFire-Lab Rev 1.3 (VzW) [I817835]	<input checked="" type="checkbox"/>
352656100818007 [I818007]	<input checked="" type="checkbox"/>
352656100817991 [I817991]	<input type="checkbox"/>
352656100817751 [I817751]	<input checked="" type="checkbox"/>
RA000503 [RA000503]	<input type="checkbox"/>
352656100817983 [I817983]	<input type="checkbox"/>
352656100302614 [I302614]	<input type="checkbox"/>
352656100817892 [I817892]	<input type="checkbox"/>
352656100818015 [I818015]	<input type="checkbox"/>
352656100597817 [RA000498]	<input type="checkbox"/>
Murphy TTD [I597486]	<input type="checkbox"/>
352656100926891 [I926891]	<input type="checkbox"/>
SandroPool RANGER900 [RA000582]	<input type="checkbox"/>
352656102543801 [RA000566]	<input type="checkbox"/>
352656100923278 [RA000060]	<input type="checkbox"/>
Contract Hour Flow Test [I597312]	<input type="checkbox"/>

APPLY CLOSE

Alarm Groups per Ranger CONFIGURE

Device Name View

SignalFire-Lab Rev 1.2 (AT&T) [I604589] VIEW

RA000497 [RA000497] VIEW

SF TANK-EH3 [I604480] VIEW

352656100817868 [I817868] VIEW

SignalFire-Lab Rev 1.3 (VzW) [I817835] VIEW

352656100818007 [I818007] VIEW

352656100817991 [I817991] VIEW

Alarm Groups for Ranger APPLY CANCEL

Ranger: SF TANK-EH3 [I604480]

Current Settings on Cloud

Group Name	In Group
Alarm Group 88	<input type="checkbox"/>
Alarm Group 23	<input type="checkbox"/>
Default Alarm Group	<input checked="" type="checkbox"/>
Alarm Group 2	<input type="checkbox"/>
Troy's Alarm Group	<input type="checkbox"/>
Alarm Group 4	<input type="checkbox"/>
Alarm Group 9	<input checked="" type="checkbox"/>
Alarm Group 93	<input type="checkbox"/>
Alarm Group 72	<input type="checkbox"/>

Alarm Groups + NEW

Group Name View

Alarm Group 88 VIEW

Alarm Group 23 VIEW

Default Alarm Group VIEW

Alarm Group 2 VIEW

Troy's Alarm Group VIEW

Alarm Group 4 VIEW

Alarm Group 9 VIEW

Alarm Group 93 VIEW

Alarm Group 72 VIEW

Alarm Group 2 CHANGE CANCEL

Name: Alarm Group 2

Remove Alarm Group

Warning: Removing alarm group cannot be undone

Users in Alarm Group CONFIGURE

Username	First Name	Last Name	Alarm Group
sfdemo@signal-fire.com	Spike	Siegel	Alarm Group 2

Rangers in Alarm Group CONFIGURE

Name	Alarm Groups
Have a HART [RA001664]	Alarm Group 2

Reports

The SF Cloud has an automated reporting function that can send either a snapshot of data or a historical csv data dump to a group of recipients on a schedule.

To create a report, go to the Reports tab and then click on the "Add Report +" button and set the report filename and display name. Next select the type of report which can be either a snapshot or history report. The enabled checkbox enables the report to run automatically on the configured schedule.

Snapshot reports can be sent out up to 4 times a day, while history reports support daily or weekly data.

Change Recipients allows you to configure one or more email addresses that the reports will be sent to

Change Columns is only valid for snapshot reports and allows the user to device up to 6 columns of data

Change Devices allows the user to select which set of RANGERS the report could contain.

The screenshot shows the 'Report Settings: new_report1' configuration page. It includes the following fields and options:

- Filename:** new_report1
- Display Name:** Custom Report
- Type:** snapshot (dropdown menu)
- Enabled:**
- Schedule:** 1 time(s) daily at 12AM (midnight). Next 5 occurrences: 1. Wed Nov 24, 2021 12:00AM UTC, 2. Thu Nov 25, 2021 12:00AM UTC, 3. Fri Nov 26, 2021 12:00AM UTC, 4. Sat Nov 27, 2021 12:00AM UTC, 5. Sun Nov 28, 2021 12:00AM UTC. A 'CHANGE SCHEDULE' button is on the right.
- Recipients:** Please specify recipients. A 'CHANGE RECIPIENTS' button is on the right.
- Columns:** 6 columns: NAME, LASTREPORTED, AIN1, DIN1, DIN2, BATTERY. A 'CHANGE COLUMNS' button is on the right.
- Devices:** All group devices. A 'CHANGE DEVICES' button is on the right.

At the bottom, there are buttons for PREVIEW, SAVE, CLONE, UNDO, and DELETE.

Note that history reports generate one .csv file per selected RANGER containing all historical data for that RANGER. If multiple RANGERS are selected one .csv file for each RANGER will be included in a .zip file.

Updating RANGER Firmware

RANGERS support Over the Air (OTA) updating of firmware. The Signal Fire Cloud Platform has tools built in to help you do this.

Single RANGER Firmware Update

On the Node Status of any RANGER, if there is an applicable firmware update available and the RANGER is online, the tile will display a button allowing you to upgrade the RANGER's firmware:

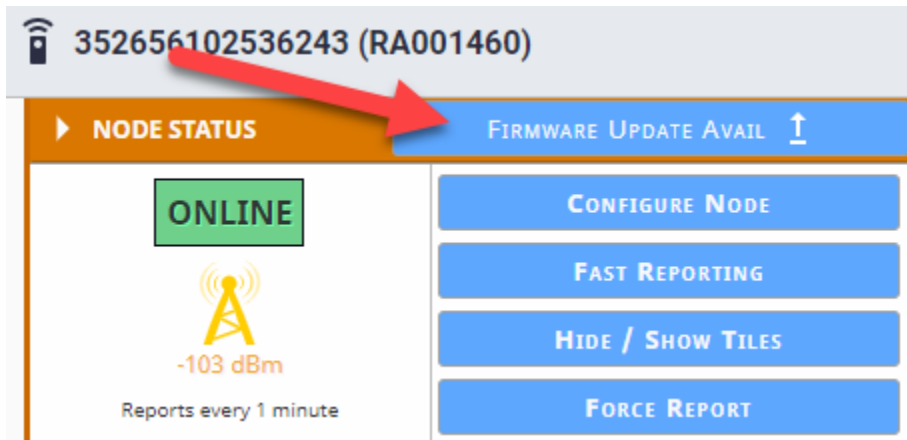

The screenshot shows a node status tile for device ID 352656102536243 (RA001460). The tile is titled 'NODE STATUS' and includes a 'FIRMWARE UPDATE AVAIL' button with an upward arrow icon. A red arrow points to this button. Other elements include an 'ONLINE' status indicator, a signal strength icon showing '-103 dBm', and a 'Reports every 1 minute' note. On the right side, there are four blue buttons: 'CONFIGURE NODE', 'FAST REPORTING', 'HIDE / SHOW TILES', and 'FORCE REPORT'.

Upon clicking the button, the Bulk Firmware update page will be brought up with the target device pre-selected for receiving an update. You may review the list of nodes eligible for a firmware update to go through with a bulk firmware update.

Bulk Firmware Update

If you have multiple RANGERS, you can update one or more of them at the same time using the Bulk Firmware Update tool.

On the home page, click the Update Firmware button:

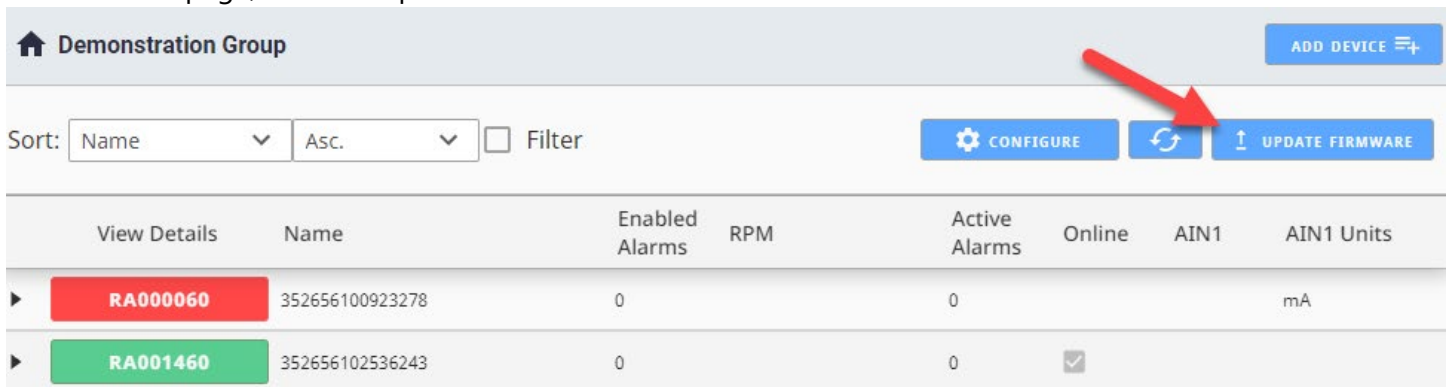

The screenshot shows the home page for a 'Demonstration Group'. At the top right, there is an 'ADD DEVICE' button. Below the group name, there are sorting options: 'Sort: Name', 'Asc.', and a 'Filter' checkbox. On the right side, there are three buttons: 'CONFIGURE', 'UPDATE FIRMWARE' (with a refresh icon), and 'UPDATE FIRMWARE' (with an upward arrow icon). A red arrow points to the 'UPDATE FIRMWARE' button with the upward arrow icon. Below the buttons is a table with columns: 'View Details', 'Name', 'Enabled Alarms', 'RPM', 'Active Alarms', 'Online', 'AIN1', and 'AIN1 Units'. The table contains two rows of data.

View Details	Name	Enabled Alarms	RPM	Active Alarms	Online	AIN1	AIN1 Units
▶	RA000060	352656100923278	0	0			mA
▶	RA001460	352656102536243	0	0	☑		

You will see a screen which lists the RANGERS in your group, along with their current firmware version, and any available firmware version. You will also see buttons to review Release Notes for the latest firmware version available.

Available Version	Release Notes
v0.1.21-v1-A-modbus	VIEW RELEASE NOTES
v0.1.21-v1-A-3v	VIEW RELEASE NOTES

You can select one or more RANGERS to update simultaneously, and then click the Update Selected button to begin the OTA firmware update process.

1 node selected
[Update Selected](#)

You will see each step of the firmware update process:

Update Status	Device	Current Version
Downloading Firmware	352656102536243 [RA001460]	v0.1.19-3v (Downloading v0.1.20-v1-3v)

Update Status	Device	Current Version
Rebooting Ranger	352656102536243 [RA001460]	v0.1.19-3v (Downloading v0.1.20-v1-3v)

You will also see the status of recently updated RANGERS:

Update Status	Device	Current Version	Available Version
Recently Updated	352656102536243 [RA001460]	v0.1.20-v1-3v	v0.1.20-v1-3v

If you trigger a firmware update and it doesn't complete successfully within 10 minutes, you will get a message that the firmware update failed. This can happen if the RANGER loses power during the update or if the download of the firmware software over the air fails. You can try again by selecting the checkbox again. There are many fail-safes in place to ensure that firmware updates will not leave the RANGER in an inoperative state.

If there is more than one person in your organization logged into the Signal Fire Cloud platform, you will be able to see firmware status updates that others perform in real time.

Technical Support and Contact Information

SignalFire Telemetry
140 Locke Dr., Suite B
Marlborough, MA 01752
(978) 212-2868
support@signal-fire.com

39

Revision	Date	Changes/Updates
1.0	05/31/22	Initial release