

*SD card real time Data Recorder
CO2, Humidity, Dew point, Temp.*

CO₂ METER + Humidity/Temp.

Model : CO2-9904SD



Your purchase of this CO₂ + HumidityTemp. meter with SD CARD DATA RECORDER marks a step forward for you into the field of precision measurement. Although this METER is a complex and delicate instrument, its durable structure developed. Please read the following instructions carefully and always keep this manual within easy reach.

OPERATION MANUAL

TABLE OF CONTENTS

1. FEATURES.....	1
2. SPECIFICATIONS.....	2
2-1 General Specifications.....	2
2-2 Electrical Specifications.....	5
3. FRONT PANEL DESCRIPTION.....	8
4 MEASURING PROCEDURE.....	10
5. OTHER FUNCTION.....	11
5-1 Data Hold.....	11
5-2 Record (Max./ Min. reading).....	11
5-3 LCD Backlight ON/OFF.....	12
6. DATALOGGER.....	13
6-1 Preparation before execute datalogger function.....	13
6-2 Auto Datalogger (Set sampling time ≥ 1 second).....	14
6-3 Manual Datalogger (Set sampling time = 0 second).....	15
6-4 Check time information.....	15
6-5 Check sampling time information.....	16
6-6 SD Card Data structure.....	16
7. Saving data from the SD card to the computer.....	18
8. ADVANCED SETTING.....	20
9. POWER SUPPLY from DC ADAPTER.....	26
10. BATTERY REPLACEMENT.....	26
11. SYSTEM RESET.....	27
12. RS232 PC SERIAL INTERFACE.....	27
13. PATENT.....	29

1. FEATURES

- * Real time recorder, save the data into the SD memory card and can be down load to the Excel, extra software is no need. User can make the further data or graphic analysis by themselves. under the Excel software.
- * At the same time, the SD memory card can record 3 probe's data (%RH/CO2/O2/Temp. or %RH/CO2/CO/Temp.) along with the time information into the one Excel file at the same time.
- * Manual datalogger is available, during execute the manual datalogger function, it can set the different location no. (position 1 to position 99).
- * Air quality measurement application, multi-function : CO2 (Carbon dioxide), CO (Carbon monoxide), O2 (Oxygen in air), Humidity, temperature measurement.
- * CO2 range : 0 to 6,000 ppm x 1 ppm.
- * O2 range : 0 to 30.0 % x 0.1 %, optional probe.
- * CO range : 0 to 1,000 ppm x 1 ppm, optional probe
- * Humidity range: 10 to 95 %RH.
- * Dew point Temp. and Wet bulb Temp. measurement.
- * Temp. range : 0 to 50.0 °C, °C/°F.
- * CO2 sensor : NDIR, long term reliability.
- * CO, O2 sensor : Galvanic cell type.
- * Humidity sensor : Precision capacitance sensor
- * Alarm setting with the beeper sound output.
- * Sampling time for data recorder is 2 seconds to 8 hours.
- * Complete set with 2 probes : CO2/Temp. probe, Humidity/Temp. probe.
- * O2/Temp. probe, CO/Temp. probe is optional.
- * Separate probe, easy for remote measurement.
- * Meter can cooperate with 2 GB to 16 GB SD card, SD card is optional.
- * RS232/USB computer interface.
- * Patented.

2. SPECIFICATIONS

2-1 General Specifications

Circuit	Custom one-chip of microprocessor LSI circuit.	
Display	LCD size : 52 mm x 38 mm LCD with green backlight (ON/OFF).	
Measurement	CO2 (Carbon dioxide) CO (Carbon monoxide), optional probe O2 (Oxygen in air), optional probe Humidity Dew point Temp., Wet bulb Temp. Temperature	
Sensor structure	CO2	NDIR * Nondispersive infrared sensor
	Humidity	Precision capacitance sensor
	O2	Galvanic cell type
	CO	Galvanic cell type
	Temp.	Precision thermistor
Datalogger Sampling Time Setting range	Auto	2 sec to 8 hour 59 min. 59 sec. <i>@ Sampling time can set to 1 second, but memory data may loss.</i>
	Manual	Push the data logger button once will save data one time. <i>@ Set the sampling time to 0 second.</i> <i>@ Manual mode, can also select the 1 to 99 position (Location) no.</i>
Data error no.	0.1% of total saved data max.	
Memory Card	SD memory card. 1 GB to 16 GB.	
Advanced setting <i>@ main setting</i>	<ul style="list-style-type: none"> * SD memory card Format * Set clock time * Set sampling time * Auto power OFF management * Set beep Sound ON/OFF * Decimal point of SD card setting * Temp. unit setting * Alarm value setting 	

Data Hold	Freeze the display reading.	
Memory Recall	Maximum & Minimum value.	
Sampling Time of Display	Approx. 1 second.	
Data Output	RS 232/USB PC computer interface. * <i>Connect the optional RS232 cable UPCB-02 will get the RS232 plug.</i> * <i>Connect the optional USB cable USB-01 will get the USB plug.</i>	
Power Supply	* Alkaline or heavy duty DC 1.5 V battery (UM3, AA) x 6 PCs, or equivalent.	
	* DC 9V adapter input. (AC/DC power adapter is optional).	
Power Current	CO2 measurement	Normal operation (w/o SD card save data and LCD Backlight is OFF) : <i>Approx. DC 136.5 mA.</i>
		When SD card save the data and LCD Backlight is OFF) : <i>Approx. DC 166 mA.</i>
	Humidity measurement	Normal operation (w/o SD card save data and LCD Backlight is OFF) : <i>Approx. DC 10.5 mA.</i>
		When SD card save the data and LCD Backlight is OFF) : <i>Approx. DC 40 mA.</i>
	O2 or CO measurement	Normal operation (w/o SD card save data and LCD Backlight is OFF) : <i>Approx. DC 12.5 mA.</i>
		When SD card save the data and LCD Backlight is OFF) : <i>Approx. DC 42.5 mA.</i>
	* <i>If LCD backlight on, the power consumption will increase approx. 12 mA.</i>	

Operating Temperature	0 to 50 °C. (32 to 122 °F).	
Operating Humidity	Less than 80% R.H.	
Weight	350 g/0.77 LB.	
Dimension	Meter	177 x 68 x 45 mm
	Humidity probe	197 mm in length.
	CO2 probe	190 x 38 x 28 mm
	O2 probe	150 x 38 x 38 mm
	CO probe	150 x 38 x 38 mm
Accessories Included	Instruction manual..... 1 PC Hard carrying case, CA-08..... 1 PC CO2 probe..... 1 PC Humidity probe..... 1 PC	
Optional Accessories	O2 probe CO probe SD memory card (2 GB) AC to DC 9V adapter. USB cable, USB-01. RS232 cable, UPCB-02. Data Acquisition software, SW-U801-WIN.	

2-2 Electrical Specifications (23± 5 °C)

CO2 (Carbon dioxide)

CO2 (Carbon dioxide) 23 ± 5 °C.	Range	0 to 6,000 ppm
	Resolution	1 ppm
	Accuracy	± 40 ppm <i>* ≤ 1,000 ppm.</i>
		± 5% of reading <i>* > 1,000 ppm ≤ 3,000 ppm.</i>
		± 250 ppm typically <i>* > 3,000 ppm.</i>
Repeatability	± 20 ppm <i>* ≤ 3,000 ppm.</i>	
Temperature	Range	0 °C to 50 °C, 32 °F to 122 °F.
	Resolution	0.1 degree
	Accuracy	°C : ± 0.8 °C °F : ± 1.5 °F.

Humidity/Temperature

Humidity	Range	5 % to 95 % R.H.
	Resolution	0.1 % R.H.
	Accuracy	≥ 70% RH : ± (3% reading + 1% RH). < 70% RH : ± 3% RH.
Temperature	Range	0 °C to 50 °C, 32 °F to 122 °F.
	Resolution	0.1 degree
	Accuracy	°C
°F		± 1.5 °F.

Dew Point Temp. (Humidity)

°C	Range	-25.3 °C to 48.9 °C
	Resolution	0.1 °C
°F	Range	-13.5 °F to 120.1 °F.
	Resolution	0.1 °F.

Remark :

- * Dew Point display value is calculated from the Humidity/Temp. measurement automatically.
- * The Dew Point accuracy is sum accuracy value of Humidity & Temperature measurement..

Wet bulb Temp. (Humidity)

°C	Range	-21.6 °C to 50.0 °C
	Resolution	0.1 °C
°F	Range	-6.9 °F to 122.0 °F.
	Resolution	0.1 °F.

Remark :

- * Wet bulb display value is calculated from the Humidity/Temp. measurement automatically.
- * The Welt bulb accuracy is sum accuracy value of Humidity & Temperature measurement..

CO (Carbon dioxide), optional probe

CO * <i>Carbon monoxide</i>	Range	0 to 1,000 ppm
	Resolution	1 ppm
	Accuracy	$\pm (5\% + 2 \text{ ppm })$
	Response time *	< 30 seconds
	Repeatability	< 2%
	Zero drift in long term	< 5 ppm
	Sensitivity drift	< 5% per year
Temperature	Range	0 °C to 50 °C, 32 °F to 122 °F.
	Resolution	0.1 degree
	Accuracy	°C : ± 0.8 °C °F : ± 1.5 °F.

O2 (Air oxygen), optional probe

O2 * <i>Air oxygen</i>	Range	0 to 30 %O2.
	Resolution	0.1 %O2.
	Accuracy	$\pm (1 \% \text{ reading} + 0.2 \% \text{ O2 })$. <i>@ After calibration</i>
	Response time	≤ 15 seconds <i>@ t 90</i>
	Overload protection	100 %O2.
	Environment pressure range	0.9 to 1.1 atmosphere.
	Expected life time	≥ 2 years.
	Alarm	If the measurement Air oxygen value is < 18.0 %O2, the buzzer will sound for warning.
Temperature	Range	0 °C to 50 °C, 32 °F to 122 °F.
	Resolution	0.1 degree
	Accuracy	°C : ± 0.8 °C °F : ± 1.5 °F.

@ Above specification tests under the environment RF Field Strength less than 3 V/M & frequency less than 30 MHz only.

3. FRONT PANEL DESCRIPTION

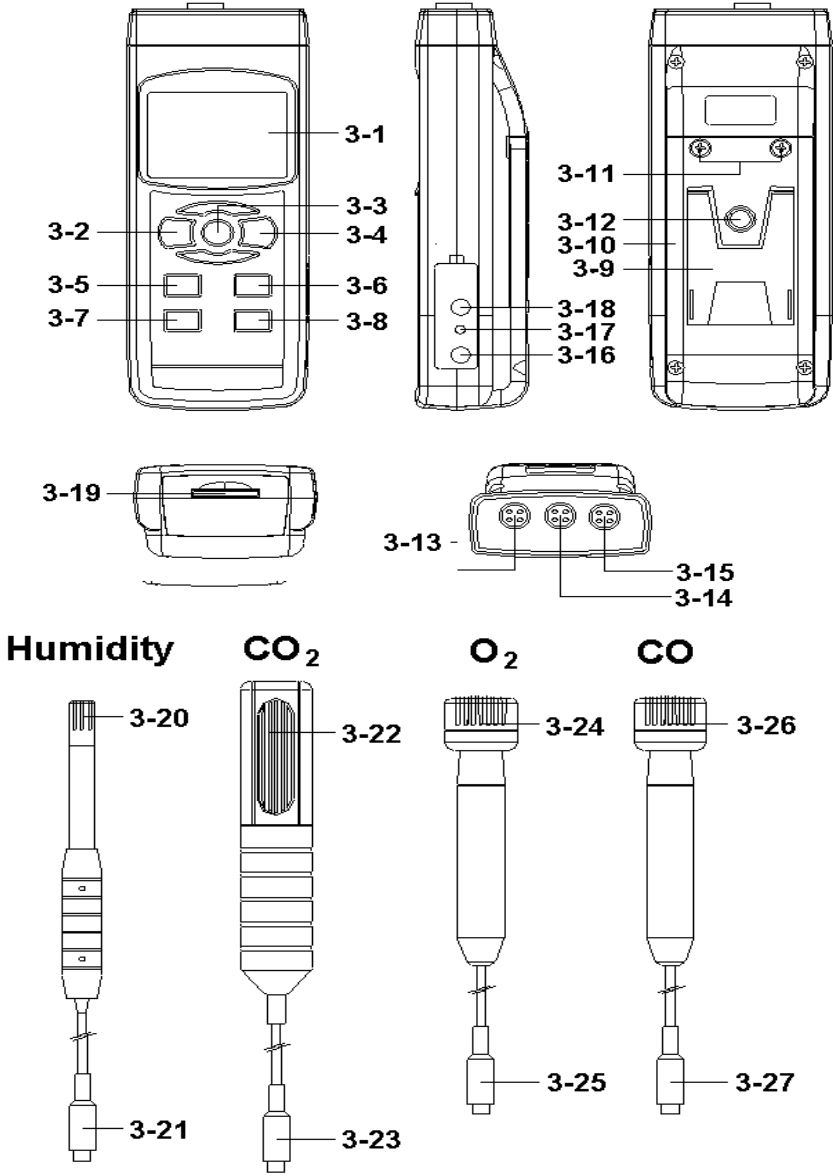

Fig. 1

- 3-1 Display
- 3-2 Power Button (Backlight Button)
- 3-3 Hold Button (ESC Button)
- 3-4 REC Button (Enter Button)
- 3-5 Alarm Button (▲ Button)
- 3-6 Function Button (▼ Button)
- 3-7 Time Button
- 3-8 Logger Button (SET Button, Sampling check)
- 3-9 Stand
- 3-10 Battery Compartment/Cover
- 3-11 Battery Cover Screw
- 3-12 Tripod Fix Nut
- 3-13 Humidity Probe Input Socket
- 3-14 CO2 Probe Input Socket
- 3-15 O2/CO Probe Input Socket
- 3-16 DC 9V Power Adapter Input Socket
- 3-17 Reset Button
- 3-18 RS-232 Output Terminal
- 3-19 SD Card Socket
- 3-20 Humidity Sensing Head
- 3-21 Humidity Probe Plug
- 3-22 CO2 Sensing Head
- 3-23 CO2 Probe Plug
- 3-24 O2 Sensing Head
- 3-25 O2 Probe Plug
- 3-26 CO Sensing Head
- 3-27 CO Probe Plug

4. MEASURING PROCEDURES

Measuring consideration

- a. The meter can plug in the max. 3 probes at the same time.
The thress prones are :
Humidity probe, CO2 probe, O2 probe.
or
Humidity probe, CO2 probe, CO probe.
- b. Though the meter can plug the above 3 probes, but the meter Display only can show the one probe measurement value at the same time.
- c. **If the meter already plug the above 3 probes, when make the SD card to record the data, it can save the 3 probes' measurement value along the time information at the same time.**

Measuring procedures

- 1) Plug in the " Plug of probe " (3-21, 3-23, 3-25, 3-27 Fig. 1) to meter's " Probe Input Socket " (3-13, 3-14, 3-15 Fig. 1)
- * *CO2 probe and Humidity probe are the standard accessories (probes are included)*
 - * *CO probe , O2 probe is the optional probe.*

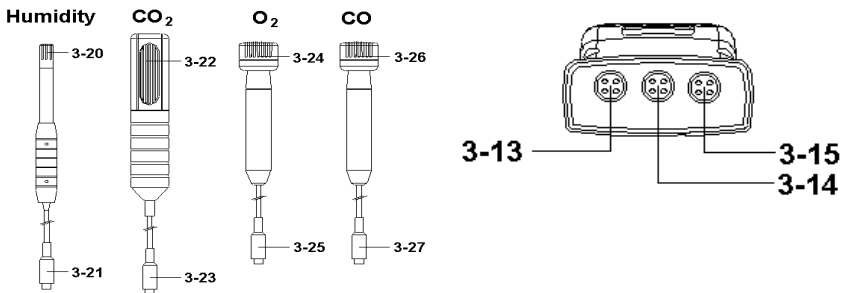

- 2) Power on the meter by pushing the " Power Button " (3-2, Fig. 1) once.
- 3) Press the " Function Button " (3-6, Fig. 1) once in sequence to select the measuring function :

<i>Display text</i>	<i>Function</i>
rH	Humidity/Temp.
dP	Dew point Temp.
_ET	Wet bulb Temp.
CO	CO/Temp.
O2	O2/Temp.
CO2	CO2/Temp.

Remark :

After select the desired function, power off the meter then power on again, the meter circuit memory will save the selected unit with default.

5. OTHER FUNCTION

5-1 Data Hold

During the measurement, press the " Hold Button " (3-3, Fig. 1) once will hold the measured value & the LCD will display a " HOLD " symbol.

Press the " Hold Button " once again will release the data hold function.

5-2 Data Record (Max., Min. reading)

- 1) The data record function records the maximum and minimum readings. Press the " REC Button " (3-4, Fig. 1) once to start the Data Record function and there will be a " REC " symbol on the display.

- 2) With the " REC " symbol on the display :
- a) Press the " REC Button " (3-4, Fig. 1) once, the " REC MAX " symbol along with the maximum value will appear on the display.
If intend to delete the maximum value, just press the " Hold Button " (3-3, Fig. 1) once, then the display will show the " REC " symbol only & execute the memory function continuously.
 - b) Press the " REC Button " (3-4, Fig. 1) again, the " REC MIN " symbol along with the minimum value will appear on the display.
If intend to delete the minimum value, just press the " Hold Button " (3-3, Fig. 1) once, then the display will show the " REC " symbol only & execute the memory function continuously.
 - c) To exit the memory record function, just press the " REC Button " for 2 seconds at least. The display will revert to the current reading.

5-3 LCD Backlight ON/OFF

After power ON, the " LCD Backlight " will light automatically. During the measurement, press the " Backlight Button " (3-2, Fig. 1) once will turn OFF the " LCD Backlight " .

Press the " Backlight Button " once again will turn ON the " LCD Backlight " again.

6. DATALOGGER

6-1 Preparation before execute datalogger function

a. Insert the SD card

* *It recommend use memory card \leq 4 GB.*

Prepare a " SD memory card " (1 GB to 16 GB, optional), insert the SD card into the " SD card socket " (3-19, Fig. 1). The front panel of the SD card should face against the down case.

b. SD card Format

If SD card just the first time use into the meter, it recommend to make the " SD card Format " at first. , please refer chapter 8-1, page 21.

* *It recommend strongly, do not use memory cards that have been formatted by other meter or by a computer. Reformat the memory card with your meter.*

c. Time setting

If the meter is used at first time, it should to adjust the clock time exactly, please refer chapter 8-2, page 21.

d. Decimal format setting



The numerical data structure of SD card is default used the " ." as the decimal, for example "20.6" "1000.53" . But in certain countries (Europe ...) is used the " , " as the decimal point, for example " 20, 6 " "1000,53". Under such situation, it should change the Decimal character at first, details of setting the Decimal point, refer to Chapter 8-6, page 24.

6-2 Auto Datalogger (Set sampling time ≥ 1 second)

a. Start the datalogger

Press the " REC Button (3-4, Fig. 1) once , the LCD will show the text " REC ", then press the " Logger Button " (3-8, Fig. 1), the bottom text " DATALOGGER " will flashing, at the same time the measuring data along the time information will be saved into the memory circuit.

Remark :

**How to set the sampling time, refer to Chapter 8-3 page 22.*

**How to set the beeper sound is enable, refer to Chapter 8-5, page 23.*

b. Pause the datalogger

During execute the Datalogger function , if press the " Logger Button " (3-8, Fig. 1) once will pause the Datalogger function (stop to save the measuring data into the memory circuit temporally). In the same time the text of " DATALOGGER " will be no flashing.

Remark :

If press the " Logger Button " (3-8, Fig. 1) once again will execute the Datalogger again, the bottom text of " DATALOGGER " will flashing .

c. Finish the Datalogger

During pause the Datalogger, press the " REC Button " (3-4, Fig. 1) continuously at least two seconds, the " REC " indication will be disappeared and finish the Datalogger.

6-3 Manual Datalogger (Set sampling time = 0 second)

a. Set sampling time is to 0 second

Press the " REC Button (3-4, Fig. 1) once , the LCD will show the text " REC ", then press the " Logger Button " (3-8, Fig. 1) once, the bottom text " DATALOGGER " will flashing once and Beeper will sound once, at the same time the measuring data along the time information will be saved into the memory circuit. The lower Display will show the Position (Location) no. and saved into the SD card too.

Remark :

During execute the Manual Datalogger, press the " ▲ Button " (3-5, Fig. 1) the lower no. (position no.) will flashing. It can use the " ▲ Button " (3-5, Fig. 1) or " ▼ Button " (3-6, Fig. 1) to set the measuring Location no. (1 to 99, for example room 1 to room 99) to identify the measurement location , the lower Display will show P x (x = 1 to 99).

b. Finish the Datalogger

Press the " REC Button " (3-4, Fig. 1) continuously at least two seconds, the " REC " indication will be disappeared and finish the Datalogger.

6-4 To check the time information

During the normal measurement screen (not execute the Datalogger),

- 1) If press " Time Button " (3-7, Fig. 1) once , the lower LCD display will present the time information of Hour/Minute/Second (h.m.s) in the lower Display.

- 2) If press " Time Button " (3-7, Fig. 1) once again , the lower LCD display will present the time information of Year/Month/Date (yy.mm.dd) in the lower Display.
- 3) If press " Time Button " (3-7, Fig. 1) once again , the LCD will return to normal screen.

6-5 Check sampling time information

During the normal measurement screen (not execute the Datalogger), If press " Sampling Button " (3-8, Fig. 1) once , the lower LCD display will present the Sampling time information in second unit.

6-6 SD Card Data structure

- 1) When the first time, the SD card is used into the meter, the SD card will generate a route :

AQA01

- 2) If the first time to execute the Datalogger, under the route AQA01\, will generate a new file name AQA01001.XLS.
After exist the Datalogger, then execute again, the data will save to the AQA01001.XLS until Data column reach to 30,000 columns, then will generate a new file, for example AQA01002.XLS
- 3) Under the folder AQA01\, if the total files more than 99 files, will generate anew route, such as AQA02\
- 4) The file's route structure :
AQA01\
 AQA01001.XLS
 AQA01002.XLS

 AQA01099.XLS

AQA02\
 AQA02001.XLS
 AQA02002.XLS

 AQA02099.XLS
AQAXX\

Remark :
XX : Max. value is 10.

7. Saving data from the SD card to the computer (EXCEL software)

- 1) After execute the Data Logger function, take away the SD card out from the " SD card socket " (3-19, Fig. 1).
- 2) Plug in the SD card into the Computer's SD card slot (if your computer build in this installation) or insert the SD card into the " SD card adapter ". then connect the " SD card adapter " into the computer.
- 3) Power ON the computer and run the " EXCEL software ". Down load the saving data file (for example the file name : AQA01001.XLS, AQA01002.XLS) from the SD card to the computer. The saving data will present into the EXCEL software screen (for example as following EXCEL data screens) , then user can use those EXCEL data to make the further Data or Graphic analysis usefully.

EXCEL graphic screen (for example, graphic)

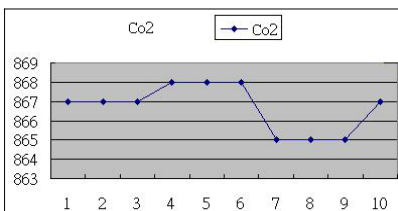
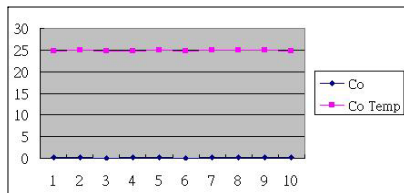
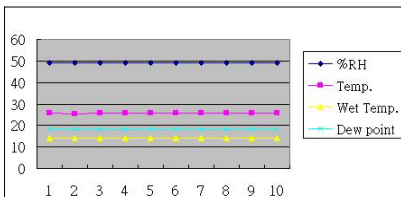

EXCEL data screen (for example)

	A	B	C	D	E	F	G	H	I	J	K
1	Position	Date	Time	Ch1_RH	RH_Unit	Ch1_rhT	rhT_unit	Ch1_DEW	dew_unit	Ch1_wet	wet_unit
2	1	2011/2/11	15:48:21	49.3	%RH	25.6	Degree_C	14.1	DEW C	18.1	WET C
3	2	2011/2/11	15:48:26	49.3	%RH	25.5	Degree_C	14	DEW C	18.1	WET C
4	3	2011/2/11	15:48:28	49.3	%RH	25.6	Degree_C	14.1	DEW C	18.1	WET C
5	4	2011/2/11	15:48:30	49.3	%RH	25.7	Degree_C	14.2	DEW C	18.2	WET C
6	5	2011/2/11	15:48:32	49.3	%RH	25.6	Degree_C	14.1	DEW C	18.1	WET C
7	6	2011/2/11	15:48:34	49.2	%RH	25.7	Degree_C	14.2	DEW C	18.2	WET C
8	7	2011/2/11	15:48:36	49.2	%RH	25.6	Degree_C	14.1	DEW C	18.1	WET C
9	8	2011/2/11	15:48:38	49.1	%RH	25.6	Degree_C	14.1	DEW C	18.1	WET C
10	9	2011/2/11	15:48:40	49.1	%RH	25.7	Degree_C	14.2	DEW C	18.2	WET C
11	10	2011/2/11	15:48:42	49.1	%RH	25.6	Degree_C	14.1	DEW C	18.1	WET C

L	M	N	O	P	Q	R	S
Ch2_CO2	CO2_unit	Ch2_Co2T	Co2T_unit	Ch3_CO	Co_unit	Ch3_CoT	CoT_unit
867	CO2 PPM	25.6	Degree_C	0.2	CO PPM	24.8	Degree_C
867	CO2 PPM	25.5	Degree_C	0.2	CO PPM	24.9	Degree_C
867	CO2 PPM	25.6	Degree_C	0.1	CO PPM	24.8	Degree_C
868	CO2 PPM	25.7	Degree_C	0.2	CO PPM	24.8	Degree_C
868	CO2 PPM	25.6	Degree_C	0.2	CO PPM	24.9	Degree_C
868	CO2 PPM	25.6	Degree_C	0.1	CO PPM	24.8	Degree_C
865	CO2 PPM	25.7	Degree_C	0.2	CO PPM	24.9	Degree_C
865	CO2 PPM	25.6	Degree_C	0.2	CO PPM	24.9	Degree_C
865	CO2 PPM	25.6	Degree_C	0.2	CO PPM	24.9	Degree_C
867	CO2 PPM	25.7	Degree_C	0.2	CO PPM	24.8	Degree_C

8. ADVANCED SETTING

Under do not execute the Datalogger function, press the " SET Button " (3-8, Fig. 1) continuously at least two seconds will enter the " Advanced Setting " mode. then press the " SET Button " (3-8, Fig. 1) once a while in sequence to select the eight main function, the display will show :

General advanced setting

- Sd F**..... SD memory card Format
- dAtE**..... Set clock time (Year/Month/Date, Hour/Minute/Second)
- SP-t**..... Set sampling time (Hour/Minute/Second)
- PoFF**..... Auto power OFF management
- bEEP**..... Set beeper sound ON/OFF
- dEC**..... Set SD card Decimal character
- t-CF**..... Set the Temp. unit to °C or °F
- AL**..... Set the alarm value
- ESC**..... Escape from the advanced setting

Special advanced setting

(only available for the CO2 function)

- High**.... Set the CO2 high compensation value (meters)
- Highf**.... Set the CO2 high compensation value (feet)

Remark :

During execute the " Advanced Setting " function, if press " ESC Button " (3-3, Fig. 1) will exit the " Advanced Setting " function, the LCD will return to normal screen.

General advanced setting

8-1 SD memory card Format

When the lower display show " Sd F "

- 1) Use the " ▲ Button " (3-5, Fig. 1) or " ▼ Button " (3-6, Fig. 1) to select the upper value to " yES " or " no ".

yES - Intend to format the SD memory card
no - Not execute the SD memory card format

- 2) If select the upper to " yES ", press the " Enter Button " (3-4, Fig. 1) once again, the Display will show text " yES Enter " to confirm again, if make sure to do the SD memory card format, then press " Enter Button " once will format the SD memory clear all the existing data that already saving into the SD card.

8-2 Set clock time (Year/Month/Date, Hour/Minute/ Second)

When the upper display show " dAtE "

- 1) Use the " ▲ Button " (3-5, Fig. 1) or " ▼ Button " (3-6, Fig. 1) to adjust the value (Setting start from Year value). After the desired value is set, press the " Enter Button " (3-4, Fig. 1) once will going to next value adjustment (for example, first setting value is Year then next to adjust Month, Date, Hour, Minute, Second value).

Remark :

The adjusted value will be flashed.

- 2) After set all the time value (Year, Month, Date, Hour, Minute, Second), press the " SET Button " (3-8, Fig. 1) once will save the time value, then the screen will jump to " Sampling time " setting screen (Chapter 8-3).

Remark :

After the time value is setting, the internal clock will run precisely even Power off if the battery is under normal condition (No low battery power).

8-3 Set sampling time (Hour/Minute/Second)

When the upper display show " SP-t "

- 1) Use the " ▲ Button " (3-5, Fig. 1) or " ▼ Button " (3-6, Fig. 1) to adjust the value (Setting start from Hour value). After the desired value is set, press the " Enter Button " (3-4, Fig. 1) once will going to next value adjustment (for example, first setting value is Hour then next to adjust Minute, Second value).

Remark :

The adjusted value will be flashed.

- 2) After set all the sampling time value (Hour, Minute, Second), press the " SET Button " (3-8, Fig. 1) once will save the sampling value with default then the screen will jump to " Auto power OFF " setting screen (Chapter 8-4).

8-4 Auto power OFF management

When the lower display show " PoFF "

- 1) Use the " ▲ Button " (3-5, Fig. 1) or " ▼ Button " (3-6, Fig. 1) to select the upper value to " yES " or " no ".

yES - Auto Power Off management will enable.
no - Auto Power Off management will disable.

- 2) After select the upper text to " yES " or " no ", press the " Enter Button " (3-4, Fig. 1) will save the setting function with default.

8-5 Set beeper sound ON/OFF

When the lower display show " bEEP "

- 1) Use the " ▲ Button " (3-5, Fig. 1) or " ▼ Button " (3-6, Fig. 1) to select the upper value to " yES " or " no ".

yES - Meter's beep sound will be ON with default.
no - Meter's beep sound will be OFF with default.
is power ON.

- 2) After select the upper text to " yES " or " no ", press the " Enter Button " (3-4, Fig. 1) will save the setting function with default.

8-6 Decimal point of SD card setting

The numerical data structure of SD card is default used the " ." as the decimal, for example "20.6" "1000.53" . But in certain countries (Europe ...) is used the " ," as the decimal point, for example " 20,6 " "1000,53". Under such situation, it should change the Decimal character at first.

When the lower display show " dEC "

- 1) Use the " ▲ Button " (3-5, Fig. 1) or " ▼ Button " (3-6, Fig. 1) to select the upper text to " USA " or " Euro " .

USA - Use " ." as the Decimal point with default.
Euro - Use " ," as the Decimal point with default.

- 2) After select the upper text to " USA " or " Euro " , press the " Enter Button " (3-4, Fig. 1) will save the setting function with default.

8-7 Select the Temp. unit to °C or °F

When the lower display show " t-CF "

- 1) Use the " ▲ Button " (3-5, Fig. 1) or " ▼ Button " (3-6, Fig. 1) to select the upper Display text to " C " or " F " .

C - Temperature unit is °C
F - Temperature unit is °F

- 2) After Display unit is selected to " C " or " F " , press the " Enter Button " (3-4, Fig. 1) will save the setting function with default.

8-8 Set the alarm value

When the lower display show " AL "

- 1) Use the " ▲ Button " (3-5, Fig. 1) or " ▼ Button " (3-6, Fig. 1) to adjust the Alarm value.
- 2) After set the Alarm value, press the " Enter Button " (3-4, Fig. 1) will save the Alarm value with default.

* **Remark :**

For the O2 function. if the measurement Air oxygen value is < 18.0 %O2, the buzzer will sound for warning.

8-9 ESC

When the display show " ESC "

When the Display show the text " ESC ", then press the " SET Button " (3-8, Fig. 1) or " ESC Button " (3-3, Fig. 1) will finish the Advanced Setting procedures.

Remark :

During execute the " Advanced Setting " function, if press " ESC Button " (3-3, Fig. 1) will exit the " Advanced Setting " function, the LCD will return to normal screen.

Special advanced setting

(only available for the CO2 function)

8-10 Set the CO2 hight compensation value (meters)

When the lower display show " hIgh- "

- 1) Use the " ▲ Button " (3-5, Fig. 1) or " ▼ Button " (3-6, Fig. 1) to adjust the CO2 height compensation value (meters) .
- 2) After set the Alarm value, press the " Enter Button " (3-4, Fig. 1) will save the CO2 height compensation (meters) value with default.

8-11 Set the CO2 hight compensation value (feet)

When the lower display show " hlgf "

- 1) Use the " ▲ Button " (3-5, Fig. 1) or " ▼ Button " (3-6, Fig. 1) to adjust the CO2 height compensation value (feet) .
- 2) After set the Alarm value, press the " Enter Button " (3-4, Fig. 1) will save the CO2 height compensation (feet) value with default.

9. POWER SUPPLY from DC ADAPTER

The meter also can supply the power supply from the DC 9V Power Adapter (optional). Insert the plug of Power Adapter into " DC 9V Power Adapter Input Socket " (3-16, Fig. 1). The meter will permanent power ON when use the DC ADAPTER power supply (The power Button function is disable).

10. BATTERY REPLACEMENT

- 1) When the left corner of LCD display show " , it is necessary to replace the battery. However, in-spec. measurement may still be made for several hours after low battery indicator appears before the instrument become inaccurate.
- 2) Loose the screws of the " Battery Cover " (3-11, Fig. 1) and take away the " Battery Cover " from the instrument and remove the battery.
- 3) Replace with DC 1.5 V battery (UM3, AA, Alkaline/heavy duty) x 6 PCs, and reinstate the cover.
- 4) Make sure the battery cover is secured after changing batteries.

11. SYSTEM RESET

If the meter happen the troubles such as :

CPU system is hold (for example, the key button can not be operated...).

Then make the system RESET will fix the problem.

The system RESET procedures will be either following method :

During the power on, use a pin to press the " Reset Button " (3-17, Fig. 1) once a while will reset the circuit system.

12. RS232 PC SERIAL INTERFACE

The instrument has RS232 PC serial interface via a 3.5 mm terminal (3-18, Fig. 1).

The data output is a 16 digit stream which can be utilized for user's specific application.

A RS232 lead with the following connection will be required to link the instrument with the PC serial port.

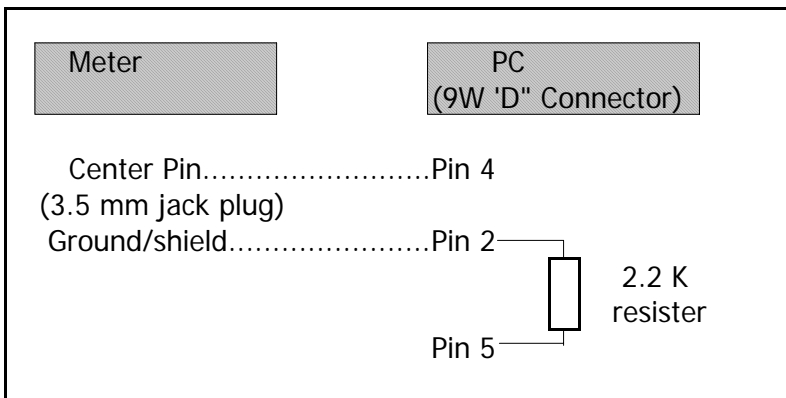

The 16 digits data stream will be displayed in the following format :

D15 D14 D13 D12 D11 D10 D9 D8 D7 D6 D5 D4 D3 D2 D1 D0

Each digit indicates the following status :

D15	Start Word		
D14	4		
D13	When send the %RH data (probe 1) = 1		
	When send the Temp./%RH. data (probe 1) = 2		
	When send the Dew point data (probe 1) = 3		
	When send the Wet bulb data (probe 1) = 4		
	When send the CO2 data (probe 2) = 5		
	When send the Temp./CO2 data (probe 2) = 6		
	When send the O2 data (probe 3) = 7		
	When send the Temp./O2 data (probe 3) = 8		
D12, D11	Annunciator for Display		
	°C = 01	PPM = 19	% RH = 04
	°F = 02	%O2 = 06	
D10	Polarity 0 = Positive 1 = Negative		
D9	Decimal Point(DP), position from right to the left 0 = No DP, 1= 1 DP, 2 = 2 DP, 3 = 3 DP		
D8 to D1	Display reading, D1 = LSD, D8 = MSD For example : If the display reading is 1234, then D8 to D1 is : 00001234		
D0	End Word		

RS232 FORMAT : 9600, N, 8, 1

Baud rate	9600
Parity	No parity
Data bit no.	8 Data bits
Stop bit	1 Stop bit

13. PATENT

The meter (SD card structure) already get patent or patent pending in following countries :

Germany	Nr. 20 2008 016 337.4
JAPAN	3151214
TAIWAN	M 358970
	M 359043
CHINA	ZL 2008 2 0189918.5
	ZL 2008 2 0189917.0
USA	Patent pending