

SD card real time datalogger, RS232/USB

RF EMF Strength Meter

Model : EMF-831SD

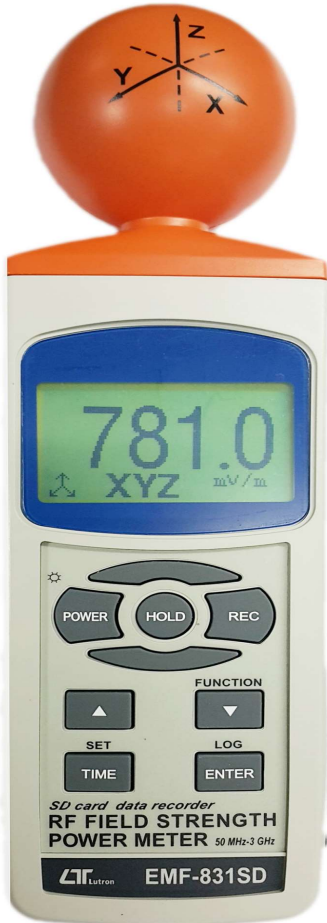

Your purchase of this Personal RF EMF Strength Meter with SD CARD DATALOGGER marks a step forward for you into the field of precision measurement. Although this METER is a complex and delicate instrument, its durable structure will allow many years of use if proper operating techniques are developed. Please read the following instructions carefully and always keep this manual within easy reach.



OPERATION MANUAL

TABLE OF CONTENTS

| | |
|--|----|
| 1. FEATURES..... | 1 |
| 2. SPECIFICATIONS..... | 2 |
| 3. FRONT PANEL DESCRIPTION..... | 5 |
| 4. MEASURING PROCEDURE..... | 6 |
| 4-1 RF EMF Strength Function selection and measurement..... | 6 |
| 4-2 Data Hold..... | 7 |
| 4-3 Data Record (Max., Min. reading)..... | 7 |
| 5. DATALOGGER..... | 8 |
| 5-1 Preparation before execute datalogger function..... | 8 |
| 5-2 Auto Datalogger (Set sampling time ≥ 1 second)..... | 9 |
| 5-3 Manual Datalogger (Set sampling time = 0 second)..... | 10 |
| 5-4 Check time and sampling time information..... | 10 |
| 5-5 SD Card Data structure..... | 11 |
| 6. Saving data from the SD card to the computer..... | 12 |
| 7. ADVANCED SETTING..... | 14 |
| 7-1 Set clock time (Year/Month/Date, Hour/Minute/ Second)..... | 14 |
| 7-2 Set sampling time | 15 |
| 7-3 Auto power OFF management | 15 |
| 7-4 Set beeper Sound ON/OFF..... | 15 |
| 7-5 Decimal point of SD card setting..... | 16 |
| 7-6 SD memory card format..... | 16 |
| 7-7 Set measurement value gain | 17 |
| 7-8 Set the alarm value | 17 |
| 7-9 Select the alarm function yes or no | 17 |
| 8. POWER SUPPLY from DC ADAPTER..... | 18 |
| 9. BATTERY REPLACEMENT..... | 18 |
| 10. RS232 PC serial interface..... | 18 |
| 11. PATENT..... | 20 |

1. FEATURES

- * For electromagnetic field strength measurement including mobile phone base station antenna radiation, RF power measurement for transmitters, wireless LAN (Wi-Fi) detection/installation, wireless communication applications (CW, TDMA, GSM, DECT) and microwave leakage
- * Measurement optimized for 900MHz, 1800MHz, 2.7GHz, and 3.5GHz
- * Non-directional (isotropic) measurement with three-channel (triaxial) measurement probe
- * Microcomputer circuit provides intelligent function and high accuracy.
- * Real time SD memory card Datalogger, it Built-in Clock and Calendar, real time data recorder, sampling time set from 1 second to 3600 seconds.
- * Manual datalogger is available (set the sampling time to 0 second), during execute the manual datalogger function, it can set the different position (location) No. (position 1 to position 99).
- * Innovation and easy operation, computer is not need to setup extra software, after execute datalogger, just take away the SD card from the meter and plug in the SD card into the computer, it can down load the all the measured value with the time information (year/month/date/ hour/minute/second) to the Excel directly, then user can make the further data or graphic analysis by themselves.
- * SD card capacity : 1 GB to 16 GB.
- * Can default auto power off or manual power off.
- * Data hold, record max. and min. reading.
- * Microcomputer circuit, high accuracy.
- * Power by UM3/AA (1.5 V) x 6 batteries or DC 9V adapter.
- * RS232/USB PC COMPUTER interface.
- * Heavy duty & compact housing case.

2. SPECIFICATIONS

2-1 General Specifications

| | | |
|--|---|---|
| Circuit | Custom one-chip of microprocessor LSI circuit. | |
| Display | LCD size : 52 mm x 30 mm | |
| Measurement method | Digital, triaxial measurement. | |
| Sensor type | Electrical-field sensors | |
| resolution | 0.1mV/m, 0.1uA/m, 0.1uW/m ² , 0.001uW/cm ² | |
| Range | autorange | |
| Datalogger Sampling Time Setting range | Auto | 2 to 3600 seconds @ <i>Sampling time can set to 1 second, but memory data may loss.</i> |
| | Manual | Push the data logger button once will save data one time. @ <i>Set the sampling time to 0 second.</i> @ <i>Manual mode, can also select the 1 to 99 position (Location) no.</i> |
| Data error no. | ≤ 0.1 % no. of total saved data typically. | |
| Memory Card | SD memory card. 1 GB to 16 GB. | |
| Advanced setting | <ul style="list-style-type: none"> * Set clock time (Year/Month/Date, Hour/Minute/ Second) * Set sampling time * Auto power OFF management * Set beep Sound ON/OFF * Decimal point of SD card setting * SD memory card Format * Set temperature unit to °C or °F | |

| | |
|--------------------------|--|
| Over Indication | Show " - - - - ". |
| Data Hold | Freeze the display reading. |
| Memory Recall | Maximum & Minimum value. |
| Sampling Time of Display | Approx. 1 second. |
| Data Output | RS 232/USB PC computer interface. * <i>Connect the optional RS232 cable UPCB-02 will get the RS232 plug.</i> * <i>Connect the optional USB cable USB-01 will get the USB plug.</i> |
| Power off | Auto shut off saves battery life or manual off by push button. |
| Operating Temperature | -20 ~ 50 °C |
| Operating Humidity | Less than 85% R.H. |
| Power Supply | * <i>Batteries(UM3, AA) x 6 PCs, or equivalent.</i> * <i>AC/DC power adapter . (adapter is optional) .</i> |
| Power Current | Normal operation (w/o SD card save data) : Approx. DC 24 mA. When SD card save the data : Approx. DC 50 mA. |
| Weight | 244 g/0.54 LB (meter only). |
| Dimension | 177 x 68 x 45 mm (7.0 x 2.7x 1.8 inch) |
| Accessories Included | * Instruction manual..... 1 PCS |
| Optional Accessories | * SD Card (4 GB) * USB cable, USB-01. * RS232 cable, UPCB-02. * Data Acquisition software, SW-U801-WIN., SW-E802. * AC to DC 9V adapter. * Hard carrying case, CA-06. * Soft carrying case, CA-05A. |

2-2 Electrical Specifications (23±5 °C , 25% ~ 75 % RH)

| | |
|---|---|
| Frequency range: | 900MHz, 1800MHz, 2.7GHz, 3.5GHz |
| Specified measurement range: CW signal (f > 900MHz): | 20 mV/m to 25.0 V/m 53 uA/m ² to 66.3mA/m 1 uW/m ² to 7.15W/m ² 0 uW/cm ² to 0.715mW/cm ² |
| Units | mV/m, V/m, μA/m, mA/m, μW/m ² , mW/m ² , W/m ² , μW/cm ² , mW/cm ² |
| Display resolution: | 0.1mV/m, 0.1uA/m, 0.1uW/m ² , 0.001uW/cm ² , 0.001W/cm ² |
| Dynamic range | Typically 75dB |
| Absolute error | 1.0dB at 1 V/m & 900 MHz |
| Frequency response | 1.0dB (50MHz to 1.9GHz) |
| Sensor (with typical CAL factors) | 2.4dB (1.9GHz to 3.5GHz) |
| Isotropy deviation | Typically 1.0dB (f>900MHz) |
| Overload limit | 1.32mW/cm ² (25V/m) |
| Thermal response (0 to 50°) | 0.5dB |

@ Above specification tests under the environment RF Field Strength less than 3 V/M & frequency less than 30 MHz only.

3. FRONT PANEL DESCRIPTION

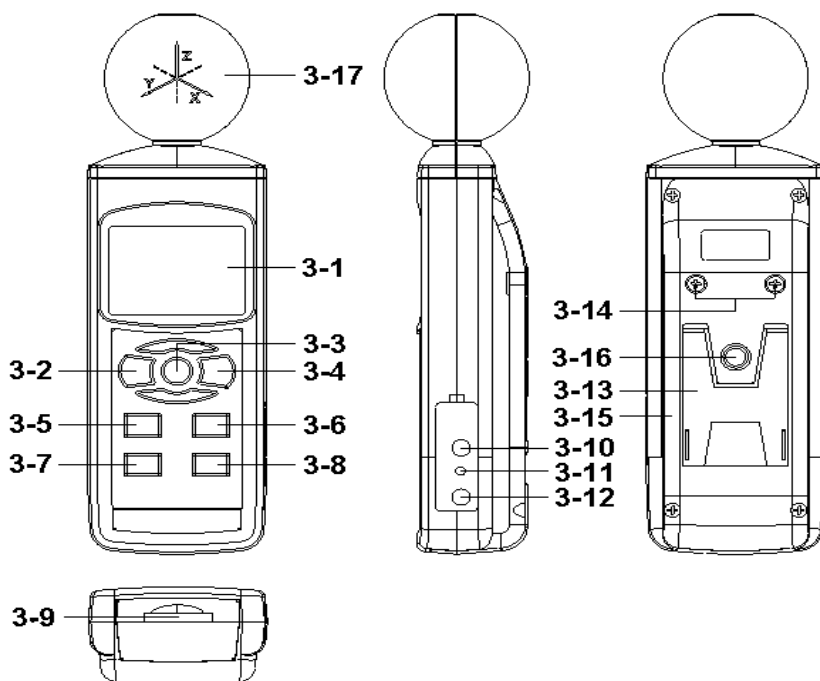

Fig. 1

- 3-1 Display.
- 3-2 Power Button
- 3-3 Hold Button
- 3-4 REC Button
- 3-5 ▲ Button (UNIT Button)
- 3-6 ▼ Button (X,Y,Z,XYZ Function Button)
- 3-7 Time Button (SET Button)
- 3-8 Enter Button (Logger Button)
- 3-9 SD card socket
- 3-10 RS-232 output terminal
- 3-11 Reset Button
- 3-12 DC 9V adapter socket
- 3-13 Stand
- 3-14 Battery Cover Screws
- 3-15 Battery compartment/Cover
- 3-16 Tripod Fix Nut
- 3-17 RF EMF detect sensor

4. MEASURING PROCEDURE

E-field sensors

The 3-channel sensor is located at the top of the meter. The three voltages generated by the sensor are fed back to the meter.

The measurement of the field is done by moving the aerial of the sensor in the desired measured environment. A direct wide band measurement is obtained of the field that the measurement sensor is subjected to. To find the value of the field emitted by a source of interference, simply point the aerial towards it and get as close as possible (the value of the field is inversely proportional to the distance of the sensor/emission source). The operator must take care not to be between the source of disturbance and the zone to be checked. The human body shields electromagnetic fields.

4-1 RF EMF Strength Function selection and measurement

1) Turn on the meter by pressing the " Power Button "
(3-2, Fig. 1) > 1.5 seconds continuously.

** Pressing the " Power Button " (3-2, Fig. 1)
continuously and > 1.5 seconds again will turn off the
meter.*

2) measurement Function select
pressing and hold the " Function Button "(3-6, Fig. 1),
to select X axis,Y axis, Z axis, and XYZ axis measurement Function.

3) measurement UNIT select
pressing and hold the " UNIT Button "(3-5, Fig. 1),
to select ...

- 1 mV/m, When Test values > 999.9 ,the unit auto chang to V/m unit ,
- 2 $\mu\text{A}/\text{m}$, When Test values > 999.9 ,the unit auto chang to mA/m unit ,
- 3 $\mu\text{W}/\text{m}^2$, When Test values > 999.9 ,the unit auto chang to mW/m² unit ,
- mW/m², When Test values > 999.9 ,the unit auto chang to W/m² unit ,
- 4 $\mu\text{W}/\text{cm}^2$, When Test values > 999.9 ,the unit auto chang to mW/cm² unit ,

4) measurement Procedure

1. Hold the meter at arm's length.
2. Make several measurements at various locations around the work place or the interested areas as described above. This is particularly important if the field conditions are unknown.

3. Pay special attention to measuring the neighboring vicinity for possible radiation sources. Apart from active sources, those components connected to a source may also act as radiators. For example, the cables used in diathermy equipment may also radiate electromagnetic energy. Note that metallic objects within the field may locally concentrate or amplify the field from a distant source.

4-2 Data Hold

During the measurement, press the " Hold Button " (3-3, Fig. 1) once will hold the measured value & the " HOLD " symbole will be light, Press the " Hold Button " once again will release the data hold function , (3-20, Fig. 1) HOLD symbole will be quenched

4-3 Data Record (Max., Min. reading)

- 1) The data record function records the maximum and minimum readings. Press the " REC Button " (3-4, Fig.1) once to start the Data Record function and there will be a " REC " symbol indicator " will be light.
- 2) With the " REC " Symbol is light on the display :
 - a) Press the " REC Button " (3-4, Fig. 1) once, the " REC and MAX Symbol indicator will be light , and the maximum value will appear on the display.
 - b) Press the " REC Button " (3-4, Fig. 1) again, the " REC and MIN " Symbol indicator will be light , and the minimum value will appear on the display.
 - c) To exit the memory record function, just press the " REC " button for 1.5 seconds at least. The display will revert to the current reading, red led indicator will be quenched

5. DATALOGGER

5-1 Preparation before execute datalogger function

a. Insert the SD card

Prepare a " SD memory card " (1 G to 16 G, optional), insert the SD card into the " SD card socket " (3-9, Fig. 1). The front panel of the SD card should face against the the down case.

*** It recommend use memory card \leq 4 GB.**

b. SD card Format

If SD card just the first time use into the meter, it recommend to make the " SD card Format " at first. , please refer chapter 7-6, (page 16).

*** It recommend strongly, do not use memory cards that have been formatted by other meter or by other installation (such as camera...) .**

Reformat the memory card with your meter.

*** If the SD memory card exist the trouble during format by the meter use the computer to reformat again can fix the problem .**

c. Time setting

If the meter is used at first time, it should to adjust the clock time exactly, please refer chapter 7-1 (page 14).

d. Decimal for the numerical data structure of SD card is

default used the "." as the decimal, for example "20.6" "1000.53" . But in certain countries (Europe ...) is used the ",", " as the decimal point, for example " 20,6 " "1000,53". Under such situation, it should change the Decimal character at first, details of setting the Decimal point, refer to Chapter 7-5, page 16.



5-2 Auto Datalogger (Set sampling time ≥ 1 second)

a. Start the datalogger

Press the " LOG Button (3-8, Fig. 1) > 1.5 seconds continuously, the LCD will show the text of " LOGGER " indicator and flashing per second, at the same time the measuring data along the time information will be saved into the memory circuit.

Remark :

- * **How to set the sampling time, refer to Chapter 7-2, page 15 .**
- * **How to set the beeper sound is enable, refer to Chapter 7-4, page 15 .**

b. Pause the datalogger

During execute the Datalogger function, if press the " LOG Button " (3-8, Fig. 1) once will pause the Datalogger function (stop to save the measuring data into the memory circuit temporarily). In the same time the " LOGGER " symbol will stop flashing.

Remark :

If press the " LOG Button " (3-8, Fig. 1) once again will execute the Datalogger again, the " LOGGER " symbol will flashing.

c. Finish the Datalogger

During execute the Datalogger function, press the " LOG Button (3-8, Fig. 1) > 1.5 seconds continuously again will finish the Datalogger function, the " LOGGER " text will be disappeared and finish the Datalogger function.

5-3 Manual Datalogger (Set sampling time = 0 second)

a. Set sampling time is to 0 second

Press the " LOG Button (3-8, Fig. 1)>1.5 second, the LCD will show the indecator " LOGGER " and " Position no. " symbol then press the " LOG Button " (3-8, Fig. 1) once , the " LOGGER " symbol will flashing once and Beeper will sound once at the same time the measuring data along the time information will be saved into the memory circuit .

Remark :

During execute the Manual Datalogger, it can use the " ▲ Button " (3-5, Fig. 1) or " ▼ Button " (3-6, Fig. 1) to set the measuring position (1 to 99, for example room 1 to room 99) to identify the measurement location , the Top Display will show P x (x = 1 to 99).

b. Finish the Datalogger

During execute the Datalogger function, press the " LOG Button (3-8, Fig. 1) > 1.5 seconds continuously again will finish the Datalooger function, the Position no. " PXX " will be disappeared and finish the Datalogger function.

5-4 Check time information

During the normal measurement (not execute the Datalogger), If press " Time " (3-7, Fig. 1) once , the LCD display will present the time information of Year/Month/Date ,Hour/ Minute/Second and the Sampling time information in sequence.

Data column reach to 30,000 columns, then will generate a new file, for example EMF01002.XLS

3) Under the folder EMF01\, if the total files more than 99 files, will generate anew route, such as EMF02\

5-5 SD Card Data structure

- 1) When the first time, the SD card is used into the meter, the SD card will generate a folder :

EMF01

- 2) If the first time to execute the Datalogger, under the route EMF01\, will generate a new file name EMF01001.XLS.
After exist the Datalogger, then execute again, the data will save to the EMF01001.XLS until Data column reach to 30,000 columns, then will generate a new file, for example EMF01002.XLS
- 3) Under the folder EMF01\, if the total files more than 99 files, will generate anew route, such as EMF02\
- 4) The file's route structure :

```
EMF01\  
    EMF01001.XLS  
    EMF01002.XLS  
  
    .....  
    EMF01099.XLS  
EMF02\  
    EMF02001.XLS  
    EMF02002.XLS  
  
    .....  
    EMF02099.XLS  
EMFXX\  
  
    .....
```

Remark : XX - Max. value is 10.

6. Saving data from the SD card to the computer (EXCEL software)

- 1) After execute the Data Logger function, take away the SD card out from the " SD card socket " (3-9, Fig. 1).
- 2) Plug in the SD card into the Computer's SD card slot (if your computer build in this installation) or insert the SD card into the " SD card adapter ". then connect the " SD card adapter " into the computer.
- 3) Power ON the computer and run the " EXCEL software ". Down load the saving data file (for example the file name : TME01001.XLS, TME01002.XLS) from the SD card to the computer. The saving data will present into the EXCEL software screen (for example as following EXCEL data screens) , then user can use those EXCEL data to make the further Data or Graphic analysis usefully.

EXCEL data screen (for example)

| Place | Date | Time | Value | Unit |
|-------|----------|----------|-------|----------|
| 1 | 2000/3/4 | 22:30:27 | 286 | XYZ mV/m |
| 2 | 2000/3/4 | 22:30:28 | 286 | XYZ mV/m |
| 3 | 2000/3/4 | 22:30:30 | 247.1 | XYZ mV/m |
| 4 | 2000/3/4 | 22:30:32 | 296.9 | XYZ mV/m |
| 5 | 2000/3/4 | 22:30:34 | 329.6 | XYZ mV/m |
| 6 | 2000/3/4 | 22:30:36 | 365.2 | XYZ mV/m |
| 7 | 2000/3/4 | 22:30:38 | 301.2 | XYZ mV/m |
| 8 | 2000/3/4 | 22:30:40 | 382.8 | XYZ mV/m |
| 9 | 2000/3/4 | 22:30:42 | 330 | XYZ mV/m |
| 10 | 2000/3/4 | 22:30:44 | 345 | XYZ mV/m |
| 11 | 2000/3/4 | 22:30:46 | 2.281 | XYZ V/m |
| 12 | 2000/3/4 | 22:30:48 | 3.257 | XYZ V/m |
| 13 | 2000/3/4 | 22:30:50 | 1.353 | XYZ V/m |
| 14 | 2000/3/4 | 22:30:52 | 1.701 | XYZ V/m |
| 15 | 2000/3/4 | 22:30:54 | 1.843 | XYZ V/m |
| 16 | 2000/3/4 | 22:30:56 | 1.074 | XYZ V/m |
| 17 | 2000/3/4 | 22:30:58 | 687.2 | XYZ mV/m |
| 18 | 2000/3/4 | 22:31:00 | 422.2 | XYZ mV/m |
| 19 | 2000/3/4 | 22:31:02 | 312.4 | XYZ mV/m |
| 20 | 2000/3/4 | 22:31:04 | 398.9 | XYZ mV/m |
| 21 | 2000/3/4 | 22:31:06 | 636.1 | XYZ mV/m |
| 22 | 2000/3/4 | 22:31:08 | 847.1 | XYZ mV/m |
| 23 | 2000/3/4 | 22:31:10 | 807.7 | XYZ mV/m |
| 24 | 2000/3/4 | 22:31:12 | 920.5 | XYZ mV/m |
| 25 | 2000/3/4 | 22:31:14 | 952.5 | XYZ mV/m |

EXCEL graphic screen (for example)

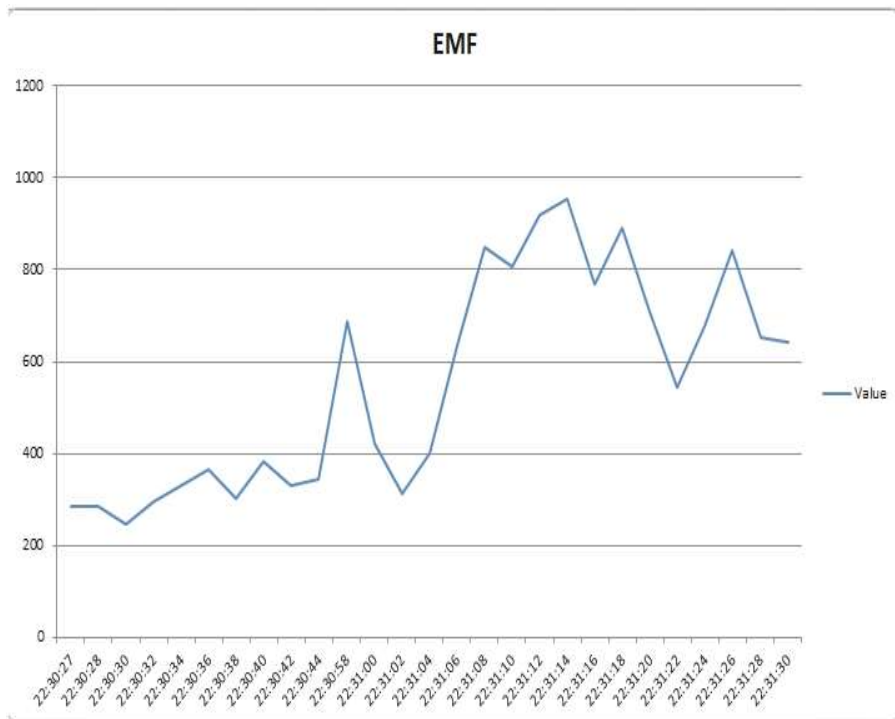

7. ADVANCED SETTING

Under do not execute the Datalogger function, press the " SET Button " (3-7, Fig. 1) continuously at least 1.5 seconds will enter the " Advanced Setting " mode. then press the " SET Button " (3-7, Fig. 1) once a while display will show :

SET DATE... Set clock time (Year/Month/Date, Hour/Minute/Second)
SP-T..... Set sampling time (Seconds)
POFF..... Auto power OFF management
BEEP..... Set beeper sound ON/OFF
DEC..... Set SD card Decimal character
SD-F..... SD memory card Format
CAL..... Set alarm mesurement value gain .
ALARM VALUE..... Set alarm value .
ALARM YES / NO... Set alarm to yes or no.

Remark :

During execute the " Advanced Setting " function,if press " Power Button " (3-2, Fig. 1) once will exit the " Advanced Setting " function, the LCD will return to normal screen.

7-1 Set clock time (Year/Month/Date,Hour/Minute/ Second)

When the lcd display show " dAtE "

- 1) Press the " Enter Button " (3-8, Fig. 1) once, ,YY symbol will light ,Use the " ▲ Button " (3-5, Fig. 1) or " ▼ Button " (3-6, Fig. 1) to adjust the correct value (Setting start from Year value). press the " Enter Button " (3-8, Fig. 1) once, After the desired value is set, YY symbol will be quenched and will going to Month adjustment (for example, first setting value is Year then next to adjust Month, Date, Hour, Minute, Second value).
- 2) After set all the time value (Year, Month, Date, Hour, Minute, Second), the screen will jump to " Set sampling time " setting screen (Chapter 7-2).

Remark :

After the time value is setting, the internal clock will run precisely even Power off if the battery is under normal condition (No low battery power).

7-2 Set sampling time (Seconds)

When the lcd display show " SP-t " ,DD/s led indicator will light

- 1) Use the " ▲ Button " (3-5, Fig. 1) or " ▼ Button " (3-6, Fig. 1) to adjust the value (2 to 3600 seconds).
- 2) After the Sampling value is selected, press the " Enter Button " (3-8, Fig. 1) will save the setting function with default.

7-3 Auto power OFF management

When the lcd display show " PoFF "

- 1) Use the " ▲ Button " (3-5, Fig. 1) or " ▼ Button " (3-6, Fig. 1) to select the led display show " YES " or " no ".

YES - Auto Power Off management will enable.
no - Auto Power Off management will disable.

- 2) After select the lcd display show " YES " or " no ", press the " Enter Button " (3-8, Fig. 1) will save the setting function with default.

7-4 Set beeper sound ON/OFF

When the lcd display show " bEEP "

- 1) Use the " ▲ Button " (3-5, Fig. 1) or " ▼ Button " (3-6, Fig. 1) to select the lcd display show " YES " or " no ".

YES - Meter's beep sound will be ON with default.
no - Meter's beep sound will be OFF with default.

- 2) After select the led display show " YES " or " no ", press the " Enter Button " (3-8, Fig. 1) will save the setting function with default.

7-5 Decimal point of SD card setting

The numerical data structure of SD card is default used the "." as the decimal, for example "20.6" "1000.53". But in certain countries (Europe ...) is used the ",", as the decimal point, for example " 20,6 " "1000,53". Under such situation, it should change the Decimal character at first.

When the lcd display show " dEC "

- 1) Use the " ▲ Button " (3-5, Fig. 1) or " ▼ Button " (3-6, Fig. 1) to select the lcd display show " USA " or " Euro ".

USA - Use "." as the Decimal point with default.
Euro - Use ",", as the Decimal point with default.

- 2) After select the display show " USA " or " Euro ", press the " Enter Button " (3-8, Fig. 1) will save the setting function with default.

7-6 SD memory card Format

When the lcd display show " SdF "

- 1) Use the " ▲ Button " (3-5, Fig. 1) or " ▼ Button " (3-6, Fig. 1) to select the lcd display to show " YES " or " no ".

YES - Intend to format the SD memory card
no - Not execute the SD memory card format

- 2) If select the lcd display show " YES ", press the " Enter Button " (3-8, Fig. 1) once , the Display will show text " Enter " and " YES " to Flashing interaction , if make sure to do the SD memory card format , then press " Enter Button " once will format the SD memory (display will show "SD CARD & For-") and clear all the existing data that already saving into the SD card.
* if no sd memory card , the Display will show text " SD CARD " and " EMPTY " then jump to next setting .

7-7 Set mesurement value gain.

When the lcd display show " CAL "

- 1) Use the " ▲ Button " (3-5, Fig. 1) or " ▼ Button "(3-6, Fig. 1) to set mesurement value gain.
- 2) After Display will show gain value, press the " Enter Button " (3-8, Fig. 1) will save the setting value with default.

7-8 Set the alarm value .

When the lcd display show " ALARM value "

- 1) Use the " ▲ Button " (3-5, Fig. 1) or " ▼ Button "(3-6, Fig. 1) to set alarm value .
- 2) After Display will show alarm value, press the " Enter Button " (3-8, Fig. 1) will save the alarm value with default.

7-9 Select the alarm function yes or no.

When the led display show " ALARM YES/NO "

- 1) Use the " ▲ Button " (3-5, Fig. 1) or " ▼ Button " (3-6, Fig. 1) to select the alarm function to show " YES " or "No ".

YES - the alarm function to enable.

NO - the alarm function to disable.

8. POWER SUPPLY from DC ADAPTER

The meter also can supply the power supply from the DC 9V Power Adapter (optional). Insert the plug of Power Adapter into " DC 9V Power Adapter Input Socket " (3-12, Fig. 1).

9. BATTERY REPLACEMENT

- 1) When the left corner of "  Lobattery text " indicator is light, it is necessary to replace the battery. However, in-spec. measurement may still be made for several hours after low battery indicator appears before the instrument become inaccurate.
- 2) Loose the " Battery Cover Screws " (3-14, Fig. 1) and take away the " Battery Cover " (3-15, Fig. 1) from the instrument and remove the battery.
- 3) Replace with DC 1.5 V battery (UM3, AA, Alkaline/heavy duty) x 6 PCs, and reinstate the cover.
- 4) Make sure the battery cover is secured after changing the battery.

10. RS232 PC SERIAL INTERFACE

The instrument has RS232 PC serial interface via a 3.5 mm terminal (3-10, Fig. 1).

The data output is a 16 digit stream which can be utilized for user's specific application.

A RS232 lead with the following connection will be required to link the instrument with the PC serial port.

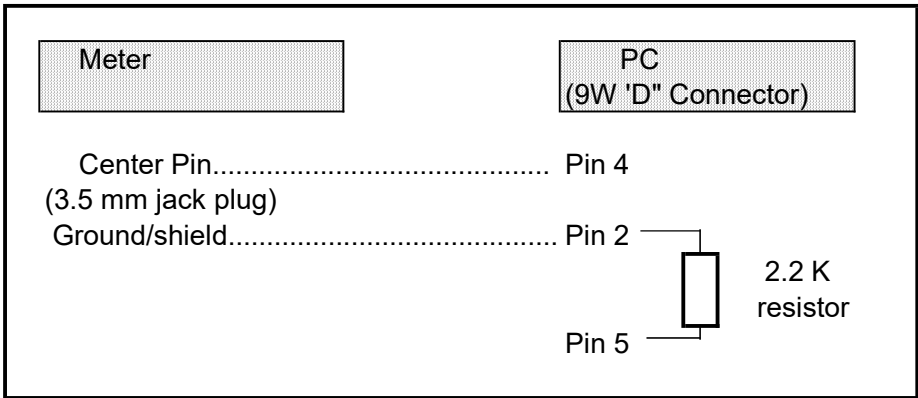

The 16 digits data stream will be displayed in the following format :

D15 D14 D13 D12 D11 D10 D9 D8 D7 D6 D5 D4 D3 D2 D1 D0

Each digit indicates the following status :

| | | | |
|----------|--|------------------------------|-------------------------|
| D15 | Start Word | | |
| D14 | 4 | | |
| D13 | | | |
| D12, D11 | Annunciator for Display | | |
| | mV/m = A7 | V/m = G9 | μ A/m = H1 |
| | mA/m = H2 | μ W/m ² = F4 | mW/m ² = F3 |
| | W/m ² = A9 | μ W/cm ² = B0 | mW/cm ² = A8 |
| D10 | Polarity 0 = Positive 1 = Negative | | |

| | |
|----------|---|
| D9 | Decimal Point(DP), position from right to the left 0 = No DP, 1= 1 DP, 2 = 2 DP, 3 = 3 DP |
| D8 to D1 | Display reading, D1 = LSD, D8 = MSD For example : If the display reading is 1234, then D8 to D1 is : 00001234 |
| D0 | End Word |

RS232 FORMAT : 9600, N, 8, 1

| | |
|--------------|-------------|
| Baud rate | 9600 |
| Parity | No parity |
| Data bit no. | 8 Data bits |
| Stop bit | 1 Stop bit |

11. PATENT

The meter (SD card structure) already get patent or patent pending in following countries :

| | |
|----------------|--|
| Germany | Nr. 20 2008 016 337.4 |
| JAPAN | 3151214 |
| TAIWAN | M 358970 M 359043 |
| CHINA | ZL 2008 2 0189918.5 ZL 2008 2 0189917.0 |
| USA | Patent pending |