

# DIGITAL ELECTRONIC TEMPERATURE CONTROLLER WITH DEFROSTING FUNCTION



## OPERATING INSTRUCTIONS

ELE21-IT-01-05-A

### EL.CO S.r.l.

Via Lago di Molveno, 20 - 36015 SCHIO (VI) ITALY

TEL. +39 0445 661722 - FAX+39 0445 661792

internet <http://www.elco-italy.com>

e-mail [info@elco-italy.com](mailto:info@elco-italy.com), [support@elco-italy.com](mailto:support@elco-italy.com)

## PREFACE

 This manual contains the information necessary for the product to be installed correctly and also instructions for its maintenance and use; we therefore recommend that the utmost attention is paid to the following instructions and to save it



This document is the exclusive property of EL.CO S. r.l. which forbids any reproduction and divulgation, even partially, of the document, unless expressly authorized.

EL.CO S.r.l. reserves the right to make any formal or functional changes at any moment and without any notice.

EL.CO S.r.l. and its legal representatives do not assume any responsibility for any damage to people, things or animals deriving from violation, wrong or improper use or in any case not in compliance with the instrument features.

 Whenever a failure or a malfunction of the device may cause dangerous situations for persons, thing or animals, please remember that the plant has to be equipped with additional electromechanical devices which will guarantee safety.

## Index

<b>1. Instrument description</b> .....	<b>1</b>
1.1 General description.....	1
1.2 Front panel pescription .....	2
<b>2. Programming</b> .....	<b>2</b>
2.1 Fast Set point programming.....	2
2.2 Standard mode parameters programming.....	2
2.3 Parameter protection using the password .....	3
2.4 Customized mode parameter programming (parameters programming level).....	3
2.5 Reset parameters to default value.....	3
2.6 Keyboard lock function.....	3
<b>3. Usage warnings</b> .....	<b>4</b>
3.1 Admitted use.....	4
<b>4. Installation warnings</b> .....	<b>4</b>
4.1 Mechanical mounting.....	4
4.2 Dimensions [mm] .....	4
4.3 Electrical connections .....	5
<b>5. Functions</b> .....	<b>5</b>
5.1 ON/Stand-by function.....	5
5.2 Normal and economic operation .....	5
5.3 Measure and display configuration .....	6
5.4 Digital input configuration.....	6
5.5 Temperature control.....	6
5.6 Compressor protection function and power-on delay .....	7
5.7 Defrost control.....	7
5.8 Alarm functions .....	8
5.9 Function of keys  and  /Aux .....	8
<b>6. Accessories</b> .....	<b>9</b>
6.1 Parameters configuration by "KeyA01" .....	9
<b>7. Programmable parameters table</b> .....	<b>10</b>
<b>8. Problems, maintenance and warranty</b> .....	<b>12</b>
8.1 Notifications .....	12
8.2 Cleaning.....	12
8.3 Warranty and Repairs.....	12
8.4 Disposal.....	12
<b>9. Technical data</b> .....	<b>12</b>
9.1 Electrical characteristics .....	12
9.2 Mechanical characteristics.....	12
9.3 Functional features .....	13
<b>10. How to order</b> .....	<b>13</b>

## 1. INSTRUMENT DESCRIPTION

### 1.1 General description

The model **ELE21** is a microprocessor based digital electronic temperature controller that is typically used in cooling applications with **ON/OFF temperature control** and **defrost control** with intervals time by **stopping compressor**

The instrument has **1 relay output** and **2 NTC temperature probes** inputs **one of which** can be **configured as digital input**; it can also be equipped with a **built-in buzzer** for **acoustic report** of the **alarms**.

## 1.2 Front panel description

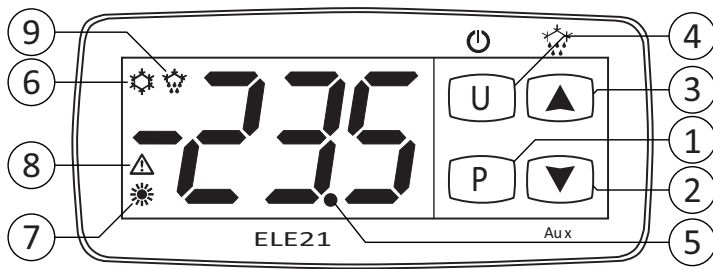

1. **[P]**: Used for setting the Set point (short press) and for programming the function parameters (pressed for 5 s). In programming mode is used to enter in parameters edit mode and confirm the values. In programming mode can be used together with the **[▲]** key to change the programming level of the parameters. When the keyboard is locked, the keys **[P]** and **[▲]** used together (hold pressed for 5 s), unlock the keyboard.
2. **[▼]/Aux**: In programming mode is used for decreasing the values to be set and for selecting the parameters. If programmed with parameter  $\epsilon Fb$  can perform, when pressed for 1 s during normal operation mode, other functions as **switching** between **Normal/Eco** mode and **turn ON/OFF** (Stand by) the controller (see "Functions of keys **[U]/[U]** and **[▼]/Aux**").
3. **[▲]/[Sun with snowflake]**: In normal mode (pressed for 5 s) can be used to **start/stop manual defrosting** (☼). In programming mode is used for increasing the values to be set and for selecting the parameters. In programming mode can be used together with **[P]** key to change parameters level. Pressed together with the **[P]** key for 5 s allows the keyboard unlock.
4. **[U]/[Power]**: Used (short press) for displaying the instrument variables (measured temperatures etc.). In programming mode can be used to return in normal mode (hold for 2 s). If programmed with parameter  $\epsilon Fb$  can perform, when pressed for 1 s during normal operation mode, other functions as **switching** between **Normal/Eco** mode and **turn ON/OFF** (Stand by) the controller (see "Functions of keys **[U]/[U]** and **[▼]/Aux**").
5. **LED dp/Stand by**: When the instrument is placed in Stand by mode, this is the only lighted LED. During the normal operation is the decimal point. In programming mode, while the parameter code is displayed, the dot indicates the parameter protection level: **not protected** (lit up), **protected** (flashing) and **hidden** (turned OFF).
6. **LED ☼**: Indicates the output status (compressor or temperature control device) when the instrument is programmed for **cooling operation**; **ON** (lit up), **OFF** (turned OFF) or **inhibited** (flashing).
7. **LED ☼**: Indicates the output status (compressor or temperature control device) when the instrument is programmed for **heating operation**; **ON** (lit), **OFF** (turned OFF) or **inhibited** (flashing).
8. **LED ▲**: Indicates the **alarm status**: **ON** (lit), **OFF** (turned OFF) or **silenced** (flashing).
9. **LED ☼**: Indicates that the **defrost is in progress**.

## 2. PROGRAMMING

### 2.1 Fast Set point programming

The normal mode to program the setpoint is done by momentarily pressing the **[P]** key, the display shows *SP* (or *SPE*) alternated to the programmed value.

To change it press the **[▲]** key to increase the value or **[▼]** to decrease it

These keys increase or decrease the value one digit at a time, but if the button is pressed for more than one second the value increase or decreases rapidly and after two seconds the speed increases even more in order to quickly reach the desired value.

However, through  $\epsilon Ed$  parameter you can determine if and which Set point can be set with the **[P]** key rapid procedure.

The parameter can have the following values:

**0F** SP/SPE cannot be changed with the **[P]** key rapid procedure (pressing/releasing the **[P]** key, nothing happens);

- 1 Only SP can be set with this procedure ("normal" Set Point);
- 2 Only SPE can be set with this procedure ("economic"/Eco Set Point);
- 3 Both SP and SPE can be set with this procedure;
- 4 To select the Active Setpoint (SP or SPE).

For example, in case the parameter  $\epsilon Ed = 1$  or **3**, the procedure is the following:

Press and release the **[P]** key, the display shows *SP* alternated to the Set Point value. To change the Set Point value, press the **[▲]** key to increase the value or **[▼]** to decrease it

If only Set Point 1 is present ( $\epsilon Ed = 1$ ), once the desired value is set, press the **[P]** button to exit the fast programming mode.

If also the "Economic" Set Point ( $\epsilon Ed = 3$ ) can be set, pressing and releasing again the **[P]** button the display shows *SPE* alternated to its programmed value.

To change the value use the **[▲]** and **[▼]** keys as for the *SP* Set Point value. Once the desired value is correctly set, press the **[P]** button to exit the fast Set Point change.

To exit the fast Setpoint programming mode push the **[P]** key after the last Set Point has been displayed or pressing no buttons for about 10 s, after which the display returns to normal operation.

### 2.2 Standard mode parameters programming

To access the instrument function parameters when password protection is disabled, press the key **[P]** and keep it pressed for about 5 seconds, after which the display shows the code that identifies the first programmable parameter

The desired parameter can be selected using the **[▲]/[▼]** keys, then, pressing the **[P]** key, the display shows the parameter code alternated to its value that can be changed with the **[▲]** and **[▼]** keys.

Once the desired value has been set, press the key **[P]** again: the new value is stored and the display shows only the code of the selected parameter

Pressing the **[▲]** and **[▼]** keys, it is possible to select another parameter and change it as described.

To exit the programming mode, press no keys for about 30 s or keep the **U** key pressed for 2 s.

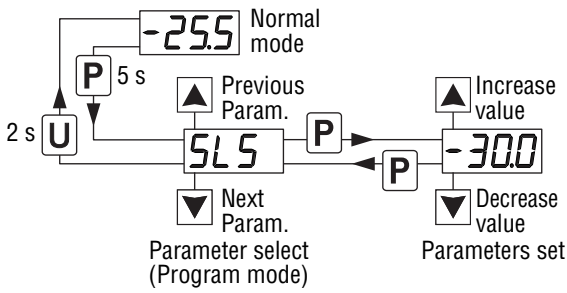

## 2.3 Parameter protection using the password

The instrument has a parameter protection function using a password that can be personalised through the  $\text{L}^{PP}$  parameter. To protect the parameters, set the desired password number in the parameter  $\text{L}^{PP}$ .

When the protection is activate, press the **P** key to access the parameters and keep it pressed for about 5 s, after which the display shows  $rP$ .

Press the **P** key, the display shows  $\square$ , using the  $\uparrow/\downarrow$  keys, insert the programmed password number and press the key **P** again.

If the password is correct the instrument displays the code of the first parameter and it will be possible to program the instrument in the same way described in the previous section.

The password protection can be disabled by setting  $\text{L}^{PP} = \text{oF}$ .

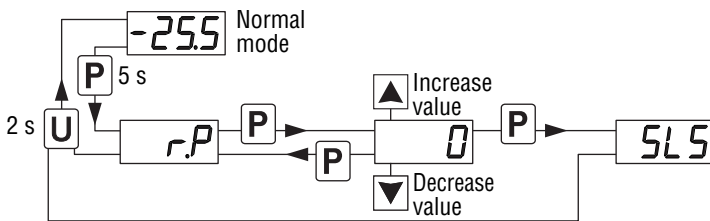

**Note:** If the Password gets lost, just switch OFF and ON the instrument, push **P** key during the initial test keeping it pressed for 5 s. In this way it is possible to access all the parameters, verify and modify the parameter  $\text{L}^{PP}$ .

## 2.4 Customized mode parameter programming (parameters programming level)

The password hides all the configuration parameters behind a factory set password to avoid unwanted changes to the controller parameters. To make a parameter accessible without having to enter the password when  $\text{L}^{PP}$  password protection is activate, use the procedure that follows:

Enter the program mode using the  $\text{L}^{PP}$  Password and select the parameter that must be accessible (no password protection).

Once a parameter is selected, if the **dp LED flashes** the parameter is programmable by entering the password (is "protected"). If the **dp LED is steady ON** the parameter is programmable without password (is "unprotected").

To change the parameter visibility, press the **P** key and keeping it pressed also press the  $\uparrow$  button.

The **dp LED** changes its state indicating the new level of parameter accessibility (**ON** = not protected; **flashing** = password protected).

In case some parameters are not protected, accessing the the programming mode the display first shows the not protected parameters, then the  $rP$  parameter (through which will be possible to access the "protected" parameters).

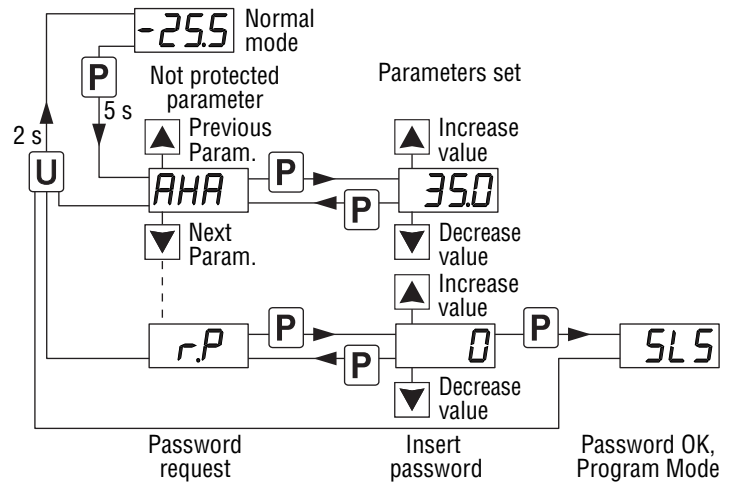

## 2.5 Reset parameters to default value

The instrument allows the reset of the parameters to values programmed in factory as default

To restore the default parameters value set value  $-48$  at  $rP$  password request. Therefore, to make the reset to the default parameters, enable the Password using the  $\text{L}^{PP}$  parameter so that the  $rP$  setting is requested, at this point insert  $-48$  instead of the programmed access password.

Once confirmed the password with the **P** key the display shows "---" for 2 s therefore the instrument resets all the parameters to factory default setting.

## 2.6 Keyboard lock function

On the instrument it is possible to completely lock the keyboard.

This function is useful when the controller is in an accessible area and the changes must be avoided.

To activate the keyboard lock it is enough program the parameter  $\text{L}^{L0}$  to a value different from **oF**.

The  $\text{L}^{L0}$  value is the keys inactivity time after which the keyboard will be automatically locked.

Therefore, pressing no buttons for the time set at  $\text{L}^{L0}$ , the instrument automatically disable the normal functions of the keys.

When the keyboard is locked, if any of the key is pressed, the display shows  $L_n$  to indicate that the lock is active.

To unlock the keyboard it is enough to contemporarily push **P** +  $\uparrow$  keys and keep them pushed for 5 s, after which the label  $L^F$  appears on the display and all the key functions will be available again.

## 3. USAGE WARNINGS

### 3.1 Admitted use

 The instrument has been projected and manufactured as a measuring and control device to be used according to EN60730-1 at altitudes operation below 2000 m.

Using the instrument for applications not expressly permitted by the above mentioned rule must adopt all the necessary protective measures.

The instrument **MUST NOT BE USED** in dangerous environments (flammable or explosive) without adequate protections. The instrument used with NTC 103AT11 probe (identifiable by the printed code "103AT-11" visible on the sensor part) is compliant with standard EN 13485 ("Thermometers for measuring the air and product temperature for the transport, storage and distribution of chilled, frozen, deep-frozen/quick-frozen food and ice cream") with the following classification: [EN13485 air, S, A, 2, -50°C +90°C]

Remember that the end user must periodically check and verify the thermometers in compliance with standard EN 13486.

The installer must ensure that the EMC rules are respected, also after the instrument installation, if necessary using proper filters.

## 4. INSTALLATION WARNINGS

### 4.1 Mechanical mounting

The instrument, in case 78 x 35 mm, is designed for flush-in panel mounting. Make a 71 x 29 mm hole and insert the instrument, fixing it with the provided special brackets.

In order to obtain the declared front protection degree, mount the gasket and use the screw type bracket (both optional).

Avoid placing the instrument in environments with very high humidity levels or dirt that may create condensation or introduction of conductive substances into the instrument

Ensure adequate ventilation to the instrument and avoid installation in containers that house devices which may overheat or which may cause the instrument to function at a higher temperature than the one permitted and declared.

Connect the instrument as far away as possible from sources of electromagnetic disturbances such as motors, power relays, relays, solenoid valves, etc..

### 4.2 Dimensions [mm]

#### 4.2.1 Mechanical dimensions

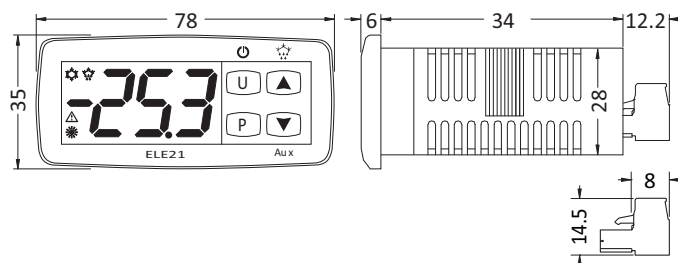

#### 4.2.2 Panel cut-out

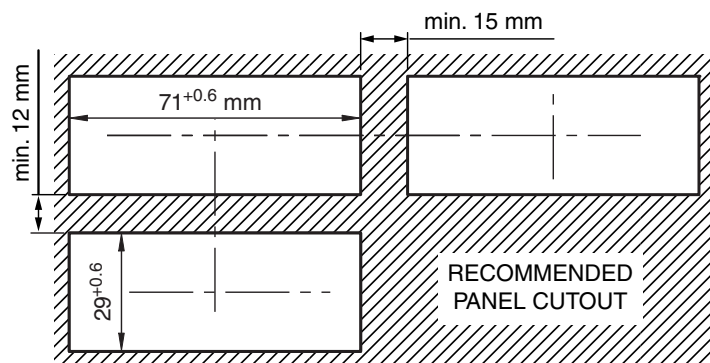

#### 4.2.3 Mounting brackets

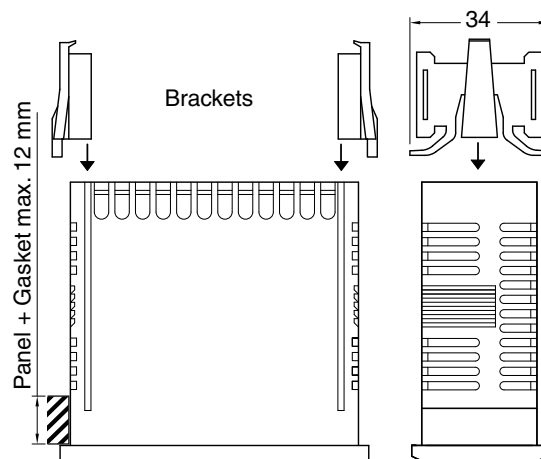

### 4.3 Electrical connections

Carry out the electrical wiring by connecting only one wire to each terminal, according to the following diagram, checking that the power supply is the same as that indicated on the instrument and that the load current absorption is no higher than the maximum electricity current permitted.

As the instrument is built-in equipment with permanent connection inside housing, it is not equipped with either switches or internal devices to protect against current overloads: the installation will include an overload protection and a two-phase circuit-breaker, placed as near as possible to the instrument and located in a position that can easily be reached by the user and marked as instrument disconnecting device which interrupts the power supply to the equipment

It is also recommended that the supply of all the electrical circuits connected to the instrument must be protected properly, using devices (ex. fuses) proportionate to the circulating currents. It is strongly recommended that cables with proper insulation, according to the working voltages and temperatures, be used.

Furthermore, the input cable of the probe has to be kept separate from line voltage wiring. If the input cable of the probe is screened, it has to be connected to the ground at only one side.

Whether the instrument is a 12 V version (Power supply code F) it is recommended to use an external TCTR transformer, or with equivalent features (class II insulation) and to use only one transformer for each instrument because there is no insulation between supply and input



We recommend that a check should be made that the parameters are those desired and that the application functions correctly **before connecting the outputs to the actuators** so as to avoid malfunctioning that may cause irregularities in the plant that could cause damage to people, things or animals.

#### 4.3.1 Electrical wiring diagram

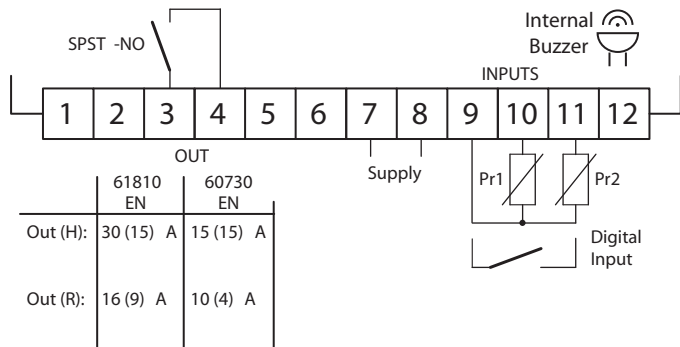

## 5. FUNCTIONS

### 5.1 ON/Stand-by function

Once powered the instrument can assume 2 different conditions:

**ON:** Means that the controller uses the control functions.

**STAND-BY:**

Means that the controller uses no control function and the display is turned off except for the Stand-by LED.

The transition between Standby and ON is equivalent to power ON the instrument providing the electrical power

In case of power failure, the system always sets itself in the condition it was in before the black-out

The ON/Stand-by function can be selected:

- With the key pressed for 1 s if  $\text{EF} = 3$ ;
- With the key /Aux pressed for 1 s if  $\text{EFb} = 3$ ;
- Using the Digital Input if parameter  $\text{IF} = 7$ ;

### 5.2 Normal and economic operation

This tool allows to pre-set two different Setpoints, one **Normal** -  $\text{SP}$  and one **Economic** -  $\text{SPE}$ .

Associated with each Setpoint there is the relative differential (hysteresis): **Normal** -  $\text{rd}$  and **Economic** -  $\text{rEd}$ .

Switching between the two modes can be **automatic** or **manual**.

#### 5.2.1 Normal/Economic operation selection

This function can be used when you need to switch two functional temperatures (eg. Day/Night or week-day/week-end). The Normal/Economic operation can be selected in manual mode:

- With the key pressed for 1 s if  $\text{EF} = 2$ ;
- With the key /Aux pressed for 1 s if  $\text{EFb} = 2$ ;
- Using the Digital Input if parameter  $\text{IF} = 6$ .

The Normal/Economic operation can be selected in automatic mode:

- Elapsed the  $\text{EEL}$  time after the door has been closed (Normal/Eco switching).
- At door opening if the  $\text{SPE}$  Setpoint is activated by  $\text{EEL}$  parameter (Eco/Normal switching).
- Elapsed the  $\text{EEL}$  time after the door has been closed and from the activation of  $\text{SPE}$  Setpoint by  $\text{EEL}$  parameter (Eco/Normal switching).

To use this function, it is necessary to set the Digital Input as:  $\text{IF} = 1, 2$  or  $3$ .

If  $\text{EEL} = \text{oF}$  the selection of Eco/Normal modes via the digital input is disabled.

If  $\text{EEL} = \text{oF}$  the time-out switching from Eco to Normal mode is disabled.

Switching to Economic mode is indicated by the label  $\text{Eco}$ .

When  $\text{dS} = \text{Ec}$  the Economic mode is pointed out with a fixed  $\text{Eco}$  label otherwise the label  $\text{Eco}$  appears every 10 s alternated to the display set with parameter  $\text{dS}$ .

The normal Set Point **SP** can be set to a value between the one set with parameter  $\text{SL5}$  and the one set with parameter  $\text{SH5}$  while the Economic Set Point **SPE** can be set to a value between the one set with parameter  $\text{SP}$  and the one set with parameter  $\text{SH5}$ .

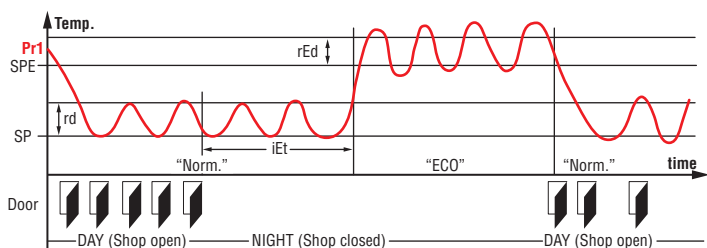

**Note:** In the following examples the Set point is generally indicated as **SP** and the differential as  $r_d$  however the instrument will act according to the Set Point and the differential selected as active.

### 5.3 Measure and display configuration

With the  $r_dP$  it is possible to select the temperature engineering unit and the desired measure resolution (**C0** = °C/1°; **C1** = °C/0.1°; **F0** = °F/1°; **F1** = °F/0.1°).

The instrument allows the measure calibration, which can be used to recalibrate the instrument according to application needs. The calibration is made by using parameters  $r_{C1}$  (input Pr1) and  $r_{C2}$  (Pr2 input).

Parameter  $r_{P2}$  allows to select the instrument usage of Pr2 measure as:

- Au** Auxiliary probe;
  - DG** Digital Input (see the Digital input functions).
- If Pr2 input is not used, set  $r_{P2} = \text{oF}$ .

Using  $r_{Ft}$  parameter can be set a software filter for the measuring the input values in order to decrease the sensibility to rapid temperature changes (increasing the sampling time). Through the  $r_{dS}$  parameter is possible to set the variable normally displayed:

- P1:** Pr1 probe measurement;
- P2:** Pr2 probe measurement;
- SP:** Active Set Point;
- EC:** Probe measure if the instrument is in Normal Mode, the label  $E_{CO}$  if the instrument is in (**Eco mode**);
- OFF:** If the numerical display must be switched off (**oF**).

When is displayed one of the measures  $r_{dS} = \text{P1/P2/EC}$  the  $r_{CU}$  parameter allows to set an offset that is to be applied only to the displayed variable (all controls will always happen according to the correct temperature value, changed only by the calibration parameters).

Regardless of what is set at  $r_{dS}$  parameter, all the measurement variables can be shown pressing the **U** key.

The display alternately shows the code that identifies the variable (see below) and its value. The variables are:

- Pr1** Probe 1 measurement;
- Pr2** Probe 2 measurement (on/oFF if Pr2 is a Digital input);
- Lt** Minimum stored Pr1 temperature;
- Ht** Maximum stored Pr1 temperature.

The peak (min./max.) temperature values of Pr1 probe are not stored in case of power failure and can be reset pressing the **▼** for 3 s elapsed which, the display shows "----" for an instant to indicate that the min./max. values have been erased and the new peak is the temperature read in that moment. The system exits the variable display mode after 15 s from the last **U** key pressure.

It is also noted that the **Pr1** probe display can also be changed by defrost display function via the  $r_{dL}$  parameter (see the Defrost function).

### 5.4 Digital input configuration

The digital input function is defined using the  $r_{Fi}$  parameter and the action is delayed for the time programmed with parameter  $r_{Et}$ . The  $r_{Fi}$  parameter can be configured for the following functions:

0. Digital input not active;
  1. Cell door opening with NO contact: at input closure (and after the  $r_{Et}$ ) the instrument displays alternately  $r_{dP}$  and the variable set at  $r_{dS}$  parameter. With this mode of operation of the digital input activates also the time set with parameter  $R_{oR}$  elapsed which the alarm is activated to warn that the door has been left open. In addition, at door opening, the instrument returns to normal operation if it was in Eco mode and the Eco mode activation was enabled through parameter  $r_{Et}$ .
  2. Similar to  $r_{Fi} = 1$ ;
  3. Cell door opening with output lock and NO contact: similar to  $r_{Fi} = 1$  but with output lock. At alarm door open intervention  $R_{oR}$  also the output is re-activated.
  4. External alarm signal with NO contact: at input closing (and after the  $r_{Et}$  time) the alarm is activated and the instrument alternately shows on the display:  $R_L$  and the variable set with parameter  $r_{dS}$ ;
  5. External alarm signal with Control output disabled and NO contact: at input closing (and after the  $r_{Et}$  time) the control output is disabled, the alarm is activated and the instrument shows on the display alternatively  $R_L$  and the variable set with parameter  $r_{dS}$ ;
  6. Normal/Economic mode selection with NO contact: at input closing (and after the  $r_{Et}$  time) the instrument switches to Economic operation mode. Opening the digital input, the instrument returns in Normal operation mode.
  7. Instrument On/Off (stand-by) selection with NO contact: at input closing (and after the  $r_{Et}$  time) the instrument is switched ON while it is placed in Stand-by mode when the digital input is open;
  8. Do not use;
- 1, -2, -3, etc.** - Features identical to the above but obtained through a NC contact and a reversed logic operation.

### 5.5 Temperature control

The instrument control is ON/OFF and acts on the output depending on the PR1 probe measuring, the Set Point  $SP$  (or  $SPE$ ), the Histeresys  $r_d$  (or  $rEd$ ) and the function mode  $r_{HC}$ .

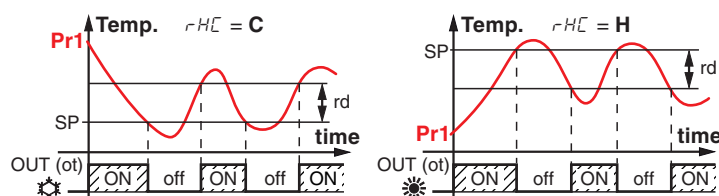

Depending on the function mode programmed with parameter  $r_{HC}$  the differential is automatically considered by the controller with positive values for a **Refrigeration** control ( $r_{HC} = C$ ) or negative values for a **Heating** control ( $r_{HC} = H$ ).

In the event of a probe error, it is possible to set the instrument so that that the output continues to work in cycles according to the times programmed with parameter  $r_{Et1}$  (activation time) and  $r_{Et2}$  (deactivation time).

If an error occurs on the probe the instrument activates the output for the time  $r_{Et1}$ , then deactivates it for the time  $r_{Et2}$  and so on whilst the error remains.

Programming  $r_{t1} = \text{oF}$  the output in probe error condition remains switched off.

Programming instead  $r_{t1}$  to any value and  $r_{t2} = \text{oF}$  the output in probe error condition remains switched ON.

Remember that the temperature regulation function can be conditioned by the *Compressor Protections*, *Delay at power ON* and *Defrost functions*.

## 5.6 Compressor protection function and power-on delay

The “**Compressor Protection**” function aims to avoid repeated compressor start-ups controlled by the instrument in cooling applications or otherwise can be used to add a timed control on the actuator control output

This function foresees 3 time controls on the switching ON of the output associated with the temperature control request. The protection consists of preventing the output being switched ON during the times set with parameters  $PP1$ ,  $PP2$  and  $PP3$  and therefore that any activation occurs only after all times are elapsed.

1. First control (parameter  $PP1$ ) foresees a delay to output activation (switching-ON delay).

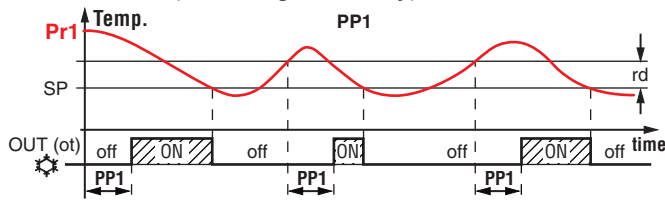

2. Second control (parameter  $PP2$ ) foresees an inhibition to the activation of the output by a time delay that starts when the output is turning OFF (delay after switching-OFF).

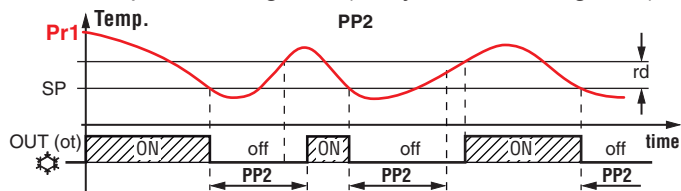

3. Third control (parameter  $PP3$ ) foresees an inhibition to the activation of the output by a time delay that starts when the output was turned ON last time (delay between two switching-ON).

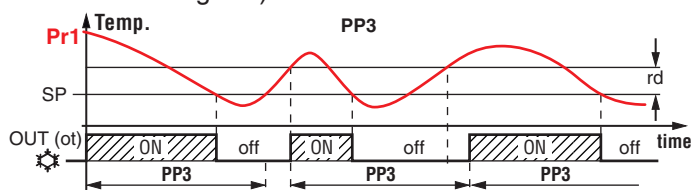

During the output inhibition the LED **OUT** (Cool ❄️ or Heat ☀️) blinks. It is also possible to prevent activation of the output after the instrument is turned ON, for the time set in the parameter  $P_{od}$ .

During the power ON delay phase, the display shows the indication **od**, alternated with the normal visualization.

All these functions are disabled if the relative parameters are set to **OFF** ( $\text{oF}$ ).

## 5.7 Defrost control

The automatic defrost control is made with the *stopping compressor* method; it occurs by interval times or after a certain time of continuous compressor functioning.

The automatic defrost function is activated when at parameter  $dd_i$  is set the defrost interval time between 2 defrost cycles.

The first defrost after power on can be set by parameter  $d5d$ .

This allows to perform the first defrost to a different interval from  $dd_i$  time.

When the instrument must perform a defrost cycle at all power ON, set parameter  $d5d = \text{oF}$ .

If all defrost cycles must be performed after the same interval time, program  $d5d = dd_i$ .

Automatic defrost function is totally disabled when  $dd_i = \text{oF}$  (included the first, regardless of the time set at  $d5d$  parameter).

The instrument provides to switch OFF the output for the  $ddE$  period of time every time expires the  $dd_i$  time (or  $d5d$  in case of first defrost after power ON).

Moreover, the instrument starts a defrost cycle when the compressor is activated continuously for the time  $d_{cd}$ .

This function is used as the continuous operation of the compressor for a long period is often and normally a symptom of low heat exchange typically caused by the frost on the evaporator

By setting  $d_{cd} = \text{oF}$  the function is disabled.

### 5.7.1 Manual defrost

To start a manual defrosting cycle, press the key when it is not in programming mode and keep it pressed for about 5 s after which, if the conditions are correct, the LED will light up and the instrument performs out a defrosting cycle.

To stop a defrosting cycle, press the key during the defrost and keep it pressed for about 5 seconds.

### 5.7.2 Display lock during Defrosting

Through parameters  $ddl$  and  $RdR$  it is possible to define the display behaviour during defrost. The  $ddl$  parameter can assume the following values.

- on** The  $ddl$  parameter locks the display at the last temperature reading during all the defrost cycle until, at the end of defrost, the temperature has not reached the lock value or the value  $[SP + rd]$  or is elapsed the time set at parameter  $RdR$
- Lb** Shows the label  $dEF$  during the defrost cycle and  $PdF$  after the defrost until, at the end of defrost, the temperature has not reached the lock value or the value  $[SP + rd]$  or is elapsed the time set on parameter  $RdR$
- oF** The display continues showing the temperature measured by the **Pr1** probe during the defrost cycle.

## 5.8 Alarm functions

The alarm conditions of the instrument are:

- Probe errors  $E1$ ,  $-E1$  and  $E2$ ,  $-E2$ ;
- Temperature alarms  $H$  and  $L$ ;
- External alarm  $AL$ ;
- Door open  $oP$ .

All active alarms are pointed out on the instrument display lighting up the LED  $\Delta$  and, if configured with parameter  $obu$ , also with the internal buzzer

Any active alarm condition is signaled lighting up the LED  $\Delta$ , while the acknowledged alarm status is shown by flashing the LED  $\Delta$ .

The buzzer (if present) can be configured to point out the alarms by programming parameter  $obu = 1$  or  $3$  and always acts to signal the acknowledgeable alarms. This means that, when activated, it can be switched OFF by briefly pressing any key.

### 5.8.1 Temperature alarms

The temperature alarm works according to **Pr1** or **AU** probes measurement, the type of alarm set in the parameter  $ARY$  the alarm thresholds set in parameters  $AHA$  (maximum alarm) and  $ALA$  (minimum alarm) and the relative differential  $AAAd$ .

Through parameter  $ARY$  it is possible to set the alarm thresholds  $AHA$  and  $ALA$  as absolute or relative to the active Set Point, must be related to  $Pr1$  or  $Au$  probes and if the message  $H$  (High alarm) and  $L$  (Low Alarm) are to be displayed at alarm intervention.

Depending on the desired alarm operating mode, parameter  $ARY$  can be set as:

- 1 Absolute alarms referred to probe  $Pr1$ , displays  $H/L$ ;
- 2 Relative Alarms referred to probe  $Pr1$ , displays  $H/L$ ;
- 3 Absolute alarms referred to probe  $Au$ , displays  $H/L$ ;
- 4 Relative Alarms referred to probe  $Au$ , displays  $H/L$ ;
- 5 Absolute alarm referred to probe  $Pr1$ , displays no labels;
- 6 Relative alarm referred to probe  $Pr1$ , displays no labels;
- 7 Absolute alarm referred to probe  $Au$ , displays no labels;
- 8 Relative alarm referred to probe  $Au$ , displays no labels.

Using some parameters it is also possible to delay the enabling and the intervention of these alarms.

These parameters are:

$APA$  Temperature alarm exclusion time on switching ON the instrument if the instrument is in alarm status when it is switched ON. If the instrument is not in alarm status when it is switched on the time  $APA$  it is not considered.

$AdA$  Temperature alarm exclusion time at the end of defrost cycle (and, if programmed, after the draining) or after a continuous cycle.

$AAE$  Temperature alarms delay activation time. Temperature alarms are enabled at the end of the exclusion times and are activated after the  $AAE$  time when the temperature measured by the probe exceeds or goes below the respective maximum and minimum alarm thresholds. The alarm thresholds are those set at parameters  $AHA$  and  $ALA$  when the alarms are set as absolute ( $ARY = 1, 3, 5, 7$ ).

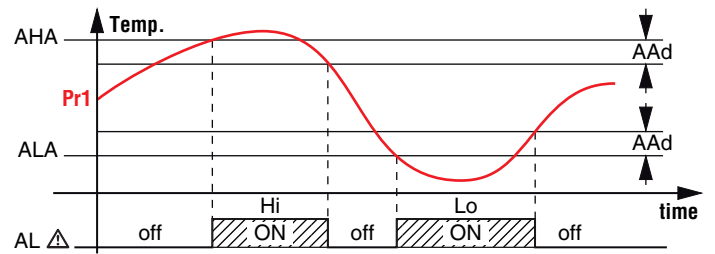

or they assume the values  $[SP + AHA]$  and  $[SP + ALA]$  if the alarms are relative ( $ARY = 2, 3, 6, 8$ ).

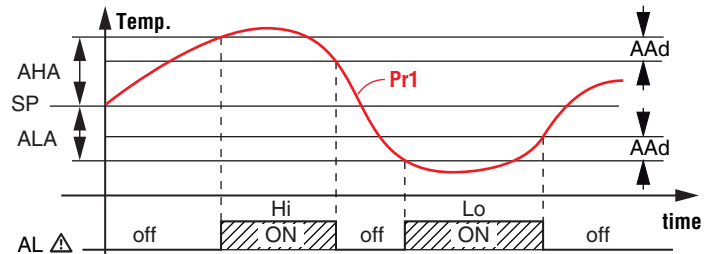

The maximum and minimum temperature alarms can be disabled by setting the related parameters  $AHA$  and  $ALA = oF$ .

The temperature alarms are signalled lighting up the alarm LED ( $\Delta$ ) and, if configured, also with the buzzer

### 5.8.2 External alarm from digital input

The instrument can signal an alarm external to the instrument using the digital input setting  $iFi = 4$  or  $5$ . The instrument signals the alarm turning ON the alarm LED ( $\Delta$ ) and displaying  $AL$  label alternated to the variable set with parameter  $id5$ . Mode  $iFi = 4$  operates no action on the control output, while  $iFi = 5$  deactivates the control output at digital input intervention.

### 5.8.3 Open door alarm

The instrument can signal the open door alarm condition using the digital input setting  $iFi = 1, 2$  and  $3$ . As the Digital input is activated, the instrument signals that the door is open showing on the display the  $oP$  label alternated to the variable set with parameter  $id5$ .

After the delay set with parameter  $AdA$  the instrument signals the Open Door alarm with the configured devices (buzzer and/or Output), lighting up the LED  $\Delta$  while showing the  $oP$  label. At the open door alarm intervention are also re-activated the inhibited outputs (compressor).

## 5.9 Function of keys $\square/\square$ and $\square/Aux$

Two of the instrument keys, in addition to their normal functions, can be configured to operate other commands.

The  $\square/\square$  key function can be defined using the  $EFb$  parameter while the  $\square/Aux$  key via parameter  $EFb$ . Both parameters have the same possibilities and can be configured to perform the following functions:

**oF** The key carries out no function;

1. Do not use;
2. Pressing the key for at least 1 s, you can sequentially select a **normal** or **eco** operating mode ( $SP/SPE$ ). A selection has been made the display shows for about 1 s the active set point code ( $SP$  or  $SPE$ );
3. Pressing the key for at least 1 s is possible to switch the instrument from **ON** to **Stand-by** state and vice-versa;
4. Do not use.



## 6. ACCESSORIES

### 6.1 Parameters configuration by “KeyA01”

The instrument is equipped with a connector that allows the transfer from and toward the instrument of the functioning parameters through the device **KeyA01** with 5 poles connector.



This device is mainly usable for the serial programming of some instruments which need to have the same parameters configuration or to keep a copy of the parameters setting of an instrument and allow its rapid retransmission.

The same device allows to connect a PC via USB with which, through the appropriate configuration software for “AT UniversalConf tools”, the operating parameters can be configured.

To use the device KeyA01 it is necessary that the device or instrument are being supplied directly or through the key.

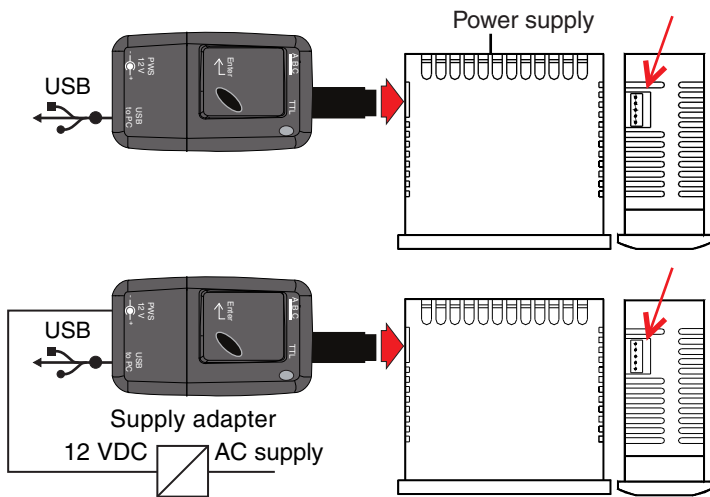

For additional info, please have a look at the KeyA01 instruction manual.

## 7. PROGRAMMABLE PARAMETERS TABLE

Here below is a description of all the parameters available on the instrument. Some of them may not be present, either due to the fact they depend on the type of instrument or because they are automatically disabled as unnecessary.

Parameter	Description	Range	Def.	Note
1 <i>SLS</i>	Minimum Set Point	-99.9 ÷ HS	-50.0	
2 <i>SHS</i>	Maximum Set Point	LS ÷ 999	99.9	
3 <i>SP</i>	Set Point	LS ÷ HS	0.0	
4 <i>SPE</i>	Set Point Eco	SP ÷ SHS	0.0	
5 <i>uP</i>	Unit of measurement and resolution (decimal point)	<b>C0</b> °C, resolution 1°; <b>F0</b> °F, resolution 1°; <b>C1</b> °C, resolution 0.1°; <b>F1</b> °F, resolution 0.1°.	C1	
6 <i>iFl</i>	Measurement filter	<b>oF</b> Filter disabled; 0.1 ÷ 20.0 s	2.0	
7 <i>iC1</i>	Pr1 Probe Calibration	-30.0 ÷ +30.0°C/°F	0.0	
8 <i>iC2</i>	Pr2 Probe Calibration	-30.0 ÷ +30.0°C/°F	0.0	
9 <i>iCU</i>	Display offset	-30.0 ÷ +30.0°C/°F	0.0	
10 <i>iP2</i>	Input Pr2 usage	<b>oF</b> Unused; <b>EP</b> Do not use; <b>Au</b> Auxliary probe; <b>dG</b> Digital Input.	dG	
11 <i>iF</i>	Function and logic functioning of the Digital Input (adding the “-” minus sign the logic is inverted)	<b>0</b> No function; <b>1, 2</b> Open Door; <b>3</b> Open Door with Output Lock; <b>4</b> External Alarm; <b>5</b> External alarm with output disabling; <b>6</b> Normal/Eco select; <b>7</b> On/Stand by select; <b>8</b> Do not use.	0	
12 <i>iL</i>	Digital Input Delay	<b>oF</b> Disabled; 0.01 ÷ 9.59 (min.s) ÷ 99.5 (min.s x 10).	oF	
13 <i>iEL</i>	Eco Mode activation delay at Door closed	<b>oF</b> Disabled; 0.01 ÷ 9.59 (min.s) ÷ 99.5 (min.s x 10).	oF	
14 <i>iEt</i>	Max. time functioning in Eco Mode	<b>oF</b> Disabled; 0.01 ÷ 9.59 (min.s) ÷ 99.5 (min.s x 10).	oF	
15 <i>iDS</i>	Variable normally displayed	<b>P1</b> Probe Pr1 measure; <b>P2</b> Probe Pr2 measure; <b>P3</b> Do not use; <b>Ec</b> Measure <b>Pr1</b> in Normal mode + <i>ELD</i> label when in ECO mode; <b>SP</b> Set Point; <b>oF</b> Display not lit.	P1	
16 <i>rD</i>	Differential (Hysteresis)	0.0 ÷ 30.0°C/°F	2.0	
17 <i>rEd</i>	Differential (Hysteresis) in ECO mode	0.0 ÷ 30.0°C/°F	2.0	
18 <i>rEt1</i>	Output activation time for Pr1 probe error	<b>oF</b> Disabled; 0.01 ÷ 9.59 (min.s) ÷ 99.5 (min.s x 10).	oF	
19 <i>rEt2</i>	Output deactivation time for Pr1 probe error	<b>oF</b> Disabled; 0.01 ÷ 9.59 (min.s) ÷ 99.5 (min.s x 10).	oF	
20 <i>rHC</i>	Output operating mode	<b>H</b> Heating; <b>C</b> Cooling; <b>nr</b> Do not use; <b>HC</b> Do not use; <b>C3</b> Do not use.	C	
21 <i>dDL</i>	Display Lock during defrost	<b>oF</b> Not active; <b>on</b> Active at last measure; <b>Lb</b> Active with label <i>dEF</i> during defrost and <i>PdF</i> at defrost.	oF	
22 <i>dCd</i>	Defrost activation time for continuous compressor operating	<b>oF</b> Disabled; 0.01 ÷ 9.59 (min.s) ÷ 99.5 (min.s x 10).	oF	
23 <i>dDE</i>	Defrost duration	<b>oF</b> Disabled; 0.01 ÷ 9.59 (min.s) ÷ 99.5 (min.s x 10).	oF	
24 <i>dd</i>	Defrosting interval	<b>oF</b> Disabled; 0.01 ÷ 9.59 (min.s) ÷ 99.5 (min.s x 10).	oF	
25 <i>dSd</i>	Delay first defrost after power-on	<b>oF</b> Defrost at power-on; 0.01 ÷ 9.59 (min.s) ÷ 99.5 (min.s x 10).	oF	
26 <i>PP1</i>	Out delay at switching-on	<b>oF</b> Disabled; 0.01 ÷ 9.59 (min.s) ÷ 99.5 (min.s x 10).	oF	
27 <i>PP2</i>	Out delay after switching OFF	<b>oF</b> Disabled; 0.01 ÷ 9.59 (min.s) ÷ 99.5 (min.s x 10).	oF	
28 <i>PP3</i>	Delay between two output switching-ON	<b>oF</b> Disabled; 0.01 ÷ 9.59 (min.s) ÷ 99.5 (min.s x 10).	oF	
29 <i>PoD</i>	Output delay at power ON	<b>oF</b> Disabled; 0.01 ÷ 9.59 (min.s) ÷ 99.5 (min.s x 10).	oF	

Parameter	Description	Range	Def.	Note
30 <i>RRY</i>	Temperature Alarm 1 type	<b>1</b> Absolute for <b>Pr1</b> with label <i>H, -Lo</i> ; <b>2</b> Relative to <b>Pr1</b> with label <i>H, -Lo</i> ; <b>3</b> Absolute for <b>Au</b> with label <i>H, -Lo</i> ; <b>4</b> Relative to <b>Au</b> with label <i>H, -Lo</i> ; <b>5</b> Absolute for <b>Pr1</b> with no label; <b>6</b> Relative to <b>Pr1</b> with no label; <b>7</b> Absolute for <b>Au</b> with no label; <b>8</b> Relative to <b>Au</b> with no label.	1	
31 <i>RRR</i>	High temperature Alarm threshold	<b>oF</b> Disabled; -99.9 ÷ +999°C/°F.	oF	
32 <i>RLR</i>	Low temperature Alarm threshold	<b>oF</b> Disabled; -99.9 ÷ +999°C/°F	oF	
33 <i>RRd</i>	Temperature Alarms Differential	0.0 ÷ 30.0°C/°F	1.0	
34 <i>RRt</i>	Temperature Alarms Delay	<b>oF</b> Disabled; 0.01 ÷ 9.59 (min.s) ÷ 99.5 (min.s x 10).	oF	
35 <i>RRP</i>	Temperature Alarms delay at power ON	<b>oF</b> Disabled; 0.01 ÷ 9.59 (h.min) ÷ 99.5 (h.min x 10).	2.00	
36 <i>RdR</i>	Temperature Alarms delay and unlock display delay after defrost	<b>oF</b> Disabled; 0.01 ÷ 9.59 (h.min) ÷ 99.5 (h.min x 10).	1.00	
37 <i>RoR</i>	Open Door Alarm Delay	<b>oF</b> Disabled; 0.01 ÷ 9.59 (min.s) ÷ 99.5 (min.s x 10).	3.00	
38 <i>ELF</i>	 Key Function	<b>oF</b> No function; <b>1</b> Do not use; <b>2</b> ECO Mode selection; <b>3</b> Switch ON/Switch OFF (Stand-by); <b>4</b> Do not use.	oF	
39 <i>ELB</i>	 Aux Key Function	<b>oF</b> Disabled; 0.01 ÷ 9.59 (min.s) ÷ 30.0 (min.s x 10).	oF	
40 <i>ELo</i>	Keyboard lock function delay	<b>oF</b> Disabled; 0.01 ÷ 9.59 (min.s) ÷ 30.0 (min.s x 10).	oF	
41 <i>ELd</i>	Set Point visibility with  key fast procedure	<b>0</b> None; <b>1</b> SP; <b>2</b> SPE; <b>3</b> SP and SPE; <b>4</b> Active SP; <b>5, 6</b> Do not use.	1	
42 <i>ELP</i>	Password to Access Parameter functions	<b>oF</b> Disabled; 001 ÷ 999.	oF	

## 8. PROBLEMS, MAINTENANCE AND WARRANTY

### 8.1 Notifications

#### 8.1.1 Error messages

Error	Reason	Action
$E1 - E1$ $E2 - E2$	The probe may be interrupted (E) or in short circuit (-E) or may measure a value outside the range allowed	Check the probe connection with the instrument and check that the probe works correctly
$EP_r$	Internal EEPROM memory error	Press <b>P</b> key
$Err$	Fatal memory error	Replace the instrument or ship to factory for repair

#### 8.1.2 Other messages

Message	Reason
$od$	Delay at power-on in progress
$Ln$	Keyboard locked
$H_i$	Maximum temperature alarm in progress
$L_o$	Minimum temperature alarm in progress
$RL$	Digital Input alarm in progress
$oP$	Door Open
$dEF$	Defrost in progress with $ddl = Lb$
$PdF$	Post-defrosting in progress with $ddl = Lb$
$Eco$	Eco Mode in progress

### 8.2 Cleaning

We recommend cleaning of the instrument only with a slightly wet cloth using water and not abrasive cleaners or solvents.

### 8.3 Warranty and Repairs

The instrument is under warranty against manufacturing flaws or faulty material, that are found within 12 months from delivery date. The warranty is limited to repairs or to the replacement of the instrument.

The eventual opening of the housing, the violation of the instrument or the improper use and installation of the product will bring about the immediate withdrawal of the warranty effects.

In the event of a faulty instrument, either within the period of warranty, or further to its expiry, please contact our sales department to obtain authorisation for sending the instrument to our company.

The faulty product must be shipped to EL.CO with a detailed description of the faults found, without any fees or charge for EL.CO, except in the event of alternative agreements.

### 8.4 Disposal

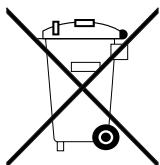

The appliance (or the product) must be disposed of separately in compliance with the local standards in force on waste disposal.

## 9. TECHNICAL DATA

### 9.1 Electrical characteristics

**Power supply:** 230 VAC, 115 VAC, 12 VAC/VDC  $\pm 10\%$ ;

**AC frequency:** 50/60 Hz;

**Power consumption:** about 3 VA;

**Inputs: 2 inputs for temperature probes:**

**NTC** (103AT-2, 10 k $\Omega$  @ 25°C);

**1 free of voltage digital input as an alternative to input Pr2;**

**Output: 1 relay output SPST-NO:**

	EN 61810	EN 60730	UL 60730
Out1 (H) - SPST-NO - 30A - 2HP 250V, 1HP 125 VAC	30 (15) A	15 (15) A	15 A Res., 96 LRA, 16 FLA
Out1 (R) - SPST-NO - 16A - 1HP 250V, 1/2HP 125 VAC	16 (9) A	10 (4) A	12 A Res., 30 LRA, 5 FLA

12 A max. for those with removable terminal model;

**Relay output Electrical life:** 100000 operations;

**Action type:** Type 1.B (EN 60730-1);

**Overvoltage category:** II;

**Protection class:** Class II;

**Isolation:** Reinforced insulation between the low voltage parts (type C or D power supply and relay output) and front panel; Reinforced insulation between the low voltage parts (type C or D power supply and relay output) and the extra low voltage section (inputs), No insulation between type F power supply and inputs.

### 9.2 Mechanical characteristics

**Housing:** Self-extinguishing plastic, UL 94 V0;

**Heat and fire resistance category:** D;

**Ball Pressure Test as described in EN60730:** accessible parts 75°C; support live parts 125°C;

**Dimensions:** 78 x 35 mm, depth 64 mm;

**Weight:** about 150 g;

**Mounting:** Incorporated flush in panel (thickness max. 12 mm) in a 71 x 29 mm hole;

**Connections:**

**Inputs:** fixed or removable screw terminal block for 0.2  $\div$  2.5 mm<sup>2</sup>/AWG 24  $\div$  14 cables;

**Power supply and Outputs:** fixed or removable screw terminal block or Faston 6.3 mm for 0.2  $\div$  2.5 mm<sup>2</sup>/AWG 24  $\div$  14 cables;

**Protection degree:** IP65 mounted with gasket and screw type bracket;

**Pollution degree:** 2;

**Operating temperature:** 0  $\div$  50°C;

**Operating humidity:** < 95 RH% with no condensation;

**Storage temperature:** -25  $\div$  +60°C.

### 9.3 Functional features

**Temperature Control:** ON/OFF mode;

**Defrost control:** Interval cycles by stopping compressor;

**Measurement range:** NTC:  $-50 \div +109^{\circ}\text{C}$ / $-58 \div +228^{\circ}\text{F}$ ;

**Display resolution:**  $1^{\circ}$  or  $0.1^{\circ}$  (range  $-99.9 \div +99.9^{\circ}$ );

**Overall accuracy:**  $\pm(0.5\% \text{ fs} + 1 \text{ digit})$ ;

**Sampling rate:** 130 ms;

**Display:** 3 Digit Red, height 17.7 mm;

**Software class and structure:** Class A;

**Compliance:** Directive 2004/108/CE (EN55022: class B;

EN61000-4-2: 8kV air, 4kV cont.; EN61000-4-3: 10V/m;

EN61000-4-4: 2kV supply and relay outputs, 1kV inputs;

EN61000-4-5: supply 2kV com. mode, 1 kV\diff. mode;

EN61000-4-6: 3V),

Directive 2006/95/CE (EN 60730-1, EN 60730-2-9),

Control 37/2005/CE (EN13485 air, S, A, 2,  $-50^{\circ}\text{C}$   $+90^{\circ}\text{C}$  with probe NTC 103AT11).

### 10. HOW TO ORDER

